

40. Matting and Framing

TABLE OF CONTENTS

40.1. Purpose	1
40.2. Factors to consider	2
40.3. Materials and equipment	6
40.4. Treatment variations	
40.4.1. Unframing and unmatting paper objects	16
40.4.2. Average size, media and support without significant problems	19
40.4.3. Thick cockled supports	30
40.4.4. Insecure media: friable or flaking	34
40.4.5. Oversize	36
40.4.6. Double-sided objects	38
40.4.7. Non-paste alternatives	40
40.4.8. Brittle supports	41
40.4.9. Supports with uneven upper edge, irregular edges	41
40.4.10 Thin papers	42
40.4.11 Heavy objects	42
40.4.12 Parchment	42
40.4.13 Photographs	43
40.4.14 Contemporary art	44
40.5. Special considerations	
40.5.1 Other attachment options	45
40.5.3 Matting without hinging	46
40.5.3 Framing without a mat	51
40.5.4. Problems encountered in travel	52
40.5.5. Adapting old mats and frames	53
40.5.6. Precautions for uncontrolled environments	54
40.5.7. Decorative mats	55

40 Matting and Framing

40.1 Purpose

To protect works of art and artifacts on paper and provide physically secure and aesthetically sympathetic housing for display, handling, transportation, storage, and support. Materials used must not react with objects in a damaging/undesirable way. Combined with proper storage, matting and framing protect the object from direct handling, prevent contact with dirt, dust, mold spores, and atmospheric pollutants and may help to protect objects by buffering rapid changes in relative humidity. Matting and framing may also serve the valuable function of substituting for drastic or expensive conservation treatment, by overmatting or selecting matboard colors which minimize damage and discoloration.

40.2 Factors to Consider before Matting/Framing

40.2.1 Appropriate or necessary housing for a given object

Matting/Framing may not be necessary in many cases.

- A. Objects which are not works of art may be more appropriately stored in folders with paper interleaving or, if they do not have friable media, in polyester film folders and displayed using non-hinging techniques.
- B. Objects accompanied by historic framing materials may require special procedures to adapt old frames and mats which are to be maintained.
- C. Individual matting/framing alters the context of objects such as sketchbook pages, posters, documents, or ephemera.
- D. Objects which have never been hinged, matted, and/or framed should be evaluated before proceeding.
- E. Typical matting and framing presentations may interfere with the visual statement of certain objects, such as contemporary and non-western works of art.

40.2.2. Owner/custodian of object

Affects budget allocations, availability of space, preparation time, how the object will look, how the object will be cared for and monitored, environment and type of display. For certain collections, optimum procedures may have to be modified without sacrificing the safety of the objects in order to arrive at realistic procedures.

40.2.3 Budget

Affects procedure, availability of materials and staff. Especially with regard to frames, cost affects the level of skill in workmanship.

40.2.4 Storage space restrictions

Space limitations may preclude the use of individual mats and necessitate the use of thinner ply matboard or folders and interleaving tissues. Compromises on matting materials should not endanger the objects.

40.2.5 Intended use of the object and life-expectancy of matting/framing**A. Display****1. Temporary**

- a. An object should undergo matting/framing procedures as infrequently as possible. Hinge removal and rehinging should be avoided. Matting/framing that allows long-term use of mat for storage and display is recommended.
- b. Matting/framing solutions for frequently displayed objects include standardized mat sizes which fit both storage boxes and display frames, use of a second window or protective covering (wrapper) for storage and study that can be turned back to reveal a clean window for display and permanent hinging to a reusable backing board.

2. Permanent

- a. Some objects, such as the U.S. Constitution, are mandated to be on permanent exhibition. It is up to conservators to make the safest possible accommodation for such circumstances.

B. Storage**1. Temporary**

Most easily accomplished with acid-free folders and acid-free interleaving tissues, except for friable media or exceptionally sensitive surfaces, such as silkscreen.

2. Permanent

See 44. Exhibition/Storage.

C. Study

1. Folders allow full access of unhinged objects. Although objects are protected in folders, some direct handling of unsecured objects may occur in study situations.
2. Matting secures objects with hinges (or by other means) and gives better support and protection. Some direct handling of objects may occur in study situations.
3. Permanent matting and framing may best protect valuable objects frequently requested for study.
4. Encapsulation allows full access and direct but protected handling of unhinged objects.

D. Travel and loan**1. Considerations for travel**

- a. Recommendations against loan or travel should be made for some objects, for example, pastel, unfixed heavy charcoal and other friable media, brittle supports, highly fugitive materials or humidity sensitive materials.

- b. Travel subjects objects to stress from vibrations, potential sudden impact and broken glass, fluctuations in environment, and the risks associated with multiple handlings. Opportunity for damage increases with each venue.
- c. Measures must be taken to assure that minimal fluctuations and cycling of relative humidity and temperature occur. (See **40.5.6- Precautions for uncontrolled environments.**)

2. Precautions for travel

- a. It is safest for objects to travel framed.
- b. More hinges may be added. Side and bottom hinges should be added to floated objects, cockled objects or objects with friable media.
- c. If object is overmatted, lower corners may be stabilized with photo corners.
- d. Tape the opening between backboards and frames to protect against dust penetration.
- e. Reinforce frames structurally. Proper hanging hardware should accompany the frame, for example, secure D-ring hanger loops, not eyes, on each side.
- f. Replace all glass with acrylic sheeting, except on friable media.
- g. Tape glass for travel to prevent slippage of glass shards and potential damage to object in the event of glass breakage (thicker glass, i.e. double strength or laminated glass, may used as an extra precaution). Also tape glass to inner rabbet of frame to act as a shock absorber and prevent shards from moving in the event of breakage. (See 40.5.4 Problems encountered in travel.)
- h. Precautions must be taken in packing to ensure adequate material to act as a buffer, against temperature and relative humidity changes.

40.2.6 Quality of environment in which the paper object will reside

- A. A controlled environment which maintains a temperature around 70 degrees F and relative humidity between 45-55% is recommended for paper objects.
- B. If objects travel or are housed in uncontrolled environments, additional measures may be taken. (See **40.5.6 Precautions for uncontrolled environments.**)
- C. Matting and framing may temporarily mitigate the effects of uncontrolled environments but cannot permanently protect objects hung on outside walls which are subject to condensation when indoor/outdoor temperatures differ greatly, light sensitive objects hung in unfiltered light and objects in damp environments, such as bathrooms, poolhouses, gazebos, waterfront homes and fountain courtyards.

40.2.7 Characteristics and Condition of Paper Object

A. Characteristics

1. Support

- a. **Size:** Overall dimension affects type and weight of hinge paper, the number of hinges and their placement. Alternative methods to hinging

may be required for oversize objects, brittle paper supports, heavy objects, objects with irregular edges and unusual supports or according to contemporary artists's preferences. (See **40.4.5 Oversize**, **40.4.7 Non-paste alternatives**, **40.4.8 Brittle supports**, **40.4.9 Supports with uneven upper or Irregular edges**, **40.4.11 Heavy Objects**, **40.4.14 Contemporary Objects**.)

- b. **Thickness:** Affects type and weight of hinge paper, the number of hinges and their placement and whether objects can be floated or require overmatting. Special preparation of matboard supports may be required to provide support for thick objects. (See 40.4.3 Thick or cockled supports.)
- c. **Weight:** Affects the type and weight of hinge paper and the number of hinges and their placement. Unusually thin or translucent objects require extra precautions for hinge application. Heavy objects may require stronger hinge paper and additional support from mats. (See 40.4.11 Heavy objects.)
- d. **Shape:** Irregular shape or uneven top edges may require custom mat cutting and floating, if condition of support permits, for best esthetic effect. Inlays may be used for works with irregular edges. (See 40.4.9 Supports with uneven upper edges or irregular edges and 40.5.1 Other attachment options.)
- e. **Hygroscopicity:** Papers resistant to aqueous adhesive or highly responsive to moisture and likely to cockle at hinges or bulge between hinges when humidity fluctuates and papers which stain easily with water require other attachment options. (See **40.5.7 Non-paste alternatives**, **40.5.2 Matting without hinging**).
- f. **"Image" dimensions:** Consider platemarks, embossed stamps, important edges (deckle edges), position of design area on total sheet or other characteristics of the media.
- g. **Material:** An extremely hygroscopic material such as parchment may require specific procedures, such as overmatting, hinging with string or encapsulation and matting (if the object will reside in a climate controlled environment). Very acidic objects may benefit from buffered matting materials.
- h. **Light sensitivity:** Affects choice of glazing material, e.g. lignin containing paper is more quickly darkened by exposure to ultraviolet rays, suggesting the use of UV-filtering glazing. May indicate restrictions on display. Restrictions and special adaptations should always be noted on frame, usually on the verso of the backboard, e.g. stipulations for low light levels, use of UV-filtering glazing, etc.
- i. **Plane:** Cockled supports, or thicker objects, such as collages, require additional depth and specially constructed mats.
- j. **Surface/finish:** Highly textured, soft uncalandered or hot press calandered finish may require caution in application of moisture and a sink mat to prevent pressure from overmatting windows.

2. Medium

- a. **Thickness:** Impasto, collage elements, etc., may require extra depth.
- b. **Friability:** Affects choice of glazing material. Static charge on acrylic sheeting may attract media particles. Loose surfaced media, e.g. pastel, charcoal, or damaged media such as cracked gouache, corroded ink or verdigris may require extra deep window mats to create greater space between surface of the media and the glazing and backboards which do not flex. (See **40.4.4 Insecure Media.**)
- c. **Light sensitivity:** For example, organic dye colors are more likely to fade with exposure to light. UV-filtering glazing and restrictions on display time should be required.
- d. **Application:** If design, signature, or inscriptions extend to sheet edges, float matting may be indicated. Double-sided windows may be required to reveal marks, notations, or images on verso. Hinging methods, such as pass-through hinges may be considered to prevent the necessity of rehinging in the future. (See **40.4.6 Double-sided objects.**)

B. Condition

1. Support

- a. **Overall strength and integrity:** Severely damaged objects cannot be displayed by hinging and matting unless they are treated by a conservator. Embrittlement, tears, or losses may preclude float matting and require overmatting to give support. Polyester film (Mylar) encapsulation may be recommended for temporary display of embrittled objects without hinging. (See **40.5.2. Matting for temporary display.**)
- b. **Edge strength and integrity:** Tears, thinning, losses, or presence of tapes or adhesives may require unusual placement of hinges and may preclude float matting.
- c. **Presence of discoloration/staining:** May indicate overmatting. May affect hinging and adhesive selection, if discoloration is water-soluble.
- d. **Original Presentation Format:** May be mimicked with placement of hinges.

2. Medium

- a. **Evidence of fading of fugitive/light sensitive media:** Limit display time.
- b. **Friability, cracking:** Due to brittle, corrosive, weak or weakened binder or use of thick paint layer on a too thin or too smooth surfaced paper. (See **40.2.7.A.2.b. Friability** above.)

40.3 Materials and Equipment

40.3.1 Hinging Papers

- A. Japanese Tissue:** Long-fibered Japanese tissue is preferred for hinging because of its chemical stability, strength, flexibility, compatability with papers of various weights and because edges may be cut straight or feathered. In selecting Japanese tissues, it is best to purchase them from a reputable source from which one can learn as much as possible about how they were made. Names are not reliable.
- B. Western papers:** Western papers are generally used as alternative techniques to hinging. (See 40.4.9A.1 Inlay)
- C. Other hinging materials:** May be required for unusual supports.
1. Rauschenberg cast paper pieces, hinged with string, unraveled, and fanned at ends for a broader area of attachment. (Adapted from parchment hinging techniques.)
 2. Large contemporary piece of heavy circular cast paper hinged with washed muslin cut on bias.
 3. Linen backed pieces hinged with airplane linen. (DvdR)
 4. Silk Threads adhered with Texicryl 13-002 (acrylic emulsion copolymer containing methyl methacrylate ethyl acrylate and ethyl methacrylate) used at the British Museum for hinging drawings.

40.3.2 Adhesives (See 46. Adhesives.)

- A. Pastes:** Cooked, water based wheat starch and rice starch pastes are preferred for adhering hinges to paper objects and attaching the hinges to the mat supports. They are reversible and are not damaging to paper supports when properly applied. They are time tested and strength of adhesion as well as the effect of moisture on supports may be varied by diluting and careful blotting. Water based, cooked pastes must be prepared fresh every few days. Anti-fungal and buffering additives are not recommended as they may discolor objects as they age (or the paper may discolor except for the area where a hinge was applied with soluble/reversible over time.
- B. Cellulose Ethers:** Some conservators feel that the adhesion of water-soluble methyl cellulose and sodium carboxy methyl cellulose is adequate for temporarily hinging small to average size objects. Cellulose ethers may also be mixed with starch paste to help control wetness or allow time for adjustment of hinge placement. They do not support mold growth and prepared solutions remain fresh longer than starch paste at room temperatures.
- For sensitive papers, particularly dimensionally unstable modern papers, the quicker drying time and the weaker contractive forces of methyl cellulose are advantageous. Also, methyl cellulose seems to stay on the surface of the paper it is applied to, allowing cleaner removal of a hinge when necessary. Methyl cellulose residues on paper also seem to cause less distortion than paste residues. (DT, FZ)
- The strength of adhesion over time is not proven and is particularly questionable on

acidic paper. Cellulose ethers appear to be susceptible to acid hydrolysis.

C. Synthetic Adhesives:

1. **Acrylic Dispersions:** Acrylic dispersions combined with Japanese tissue have been used for heat-setting hinges which can be adhered using tacking irons or by applying solvents. (Such commercial preparations are generally not recommended for long-term hinging as formulations can change without notice and one cannot be certain of all ingredients.) Acrylic dispersions such as Beva 371, Lascaux 360HV and 498HV and Rhoplex AC33 and AC234 are all butyl acrylates with added thickeners (generally polymethacrylic acid), extenders, preservatives and dispersants. It is these additives which tend to produce crosslinking reactions (and insolubility), yellowing and acidity. According to the literature, Lascaux emulsions remain soluble in alcohol, acetone and aromatics. Rhoplex and Beva are soluble in naphtha and toluene. They are not water soluble after drying. (Empirically, they are not completely or easily reversible.) For heat setting applications, Lascaux 360HV and 498HV, with the relatively low glass transition temperature of 110-120 degrees F, may be preferred to the Rhoplex ($T_g = 190$ degrees F) or Beva ($T_g = 160$ degrees F) formulations. Acrylic dispersions may be mixed with cellulose ethers to improve reversibility and cut strength of adhesion.

Acrylic dispersions, such as the polyvinyl acetate dispersion Jade 403, are more widely used in matting and framing for constructing deep or sink mats, attaching photo corners, etc. and not in direct contact with objects.

Elvace 1874, a vinyl acetate-ethylene latex copolymer dispersion, is no longer manufactured by Dupont. The product and patent were purchased by Reichhold Chemicals, Inc., who have renamed it Elvace 40-704. The product is unchanged and still has the same problems. It has a shelf life of one year and can only be purchased from Reichhold in 55 gallon drums. Elvace has a pH of 5.4-6.2 when dry and is quicker drying than Jade. Jade and Elvace mixtures are also useful.

2. **Acrylic or PVA Resins In Solvent Systems:** Paper/synthetic hinge systems using Japanese tissue with acrylic or polyvinyl acetate resins in solvent systems (such as PVA-AYAT in toluene) may be preferred because they contain no unknown additives. Polyvinyl acetate resins AYAF, AYAA and AYAC are soluble in alcohol, toluene and acetone. For use as a hinging adhesive, they may be solvent or heat-activated [glass transition temperatures are 16°C (AYAC), 21°C (AYAA), 24°C (AYAF), and 26°C (AYAT)]. PVA resins are not as flexible as acrylic resins, have neutral pH, and are the strongest adhesives.

The acrylic ester resin Acryloid B-72, a methyl acrylate/ethyl acrylate copolymer, is soluble in ethanol, toluene, xylene and acetone, among others. It is one of the most stable resins used in conservation. As a copolymer, it is internally plasticized without the addition of plasticizers used for polymerized monomers which can separate from the resin. The pH of the resin in solvent is neutral and glass transition temperature for heatsetting applications is 40 degrees C.

- D. Commercially Prepared Water-Activated Adhesives:** Such commercial preparations are not recommended for direct application to objects as hinges because of their uncertain compositions.
1. **Linen tapes with water-soluble adhesive:** Linen hinges with water-soluble adhesive, usually dextrin and animal glue, are generally too strong and inflexible for hinging, they cause impressions in paper surfaces and permanent damage to delicate supports by breaking objects at the interface of support and hinge. The adhesive requires considerable quantities of water to remove, which can cause permanent damage to the object to which they are applied.
 2. **Postage stamps and glassine hinges:** Generally are not strong enough, often detaching from the object. The water-moistenable adhesive is usually dextrin. Postage stamps may be handy in emergency situations.
 3. **Gummed Kraft paper tape:** When used for hinging, this presents the same problems as linen tape. The adhesive is generally animal glue made water-activated with dextrin and additives such as sodium chloride and calcium chloride.
 4. **Acid-Free Paper with Dextrin Adhesive:** Better than stamps because paper is finer, better than glassine as paper is less brittle. May be useful for hinging a small object if dried under pressure as for starch paste adhesives. This may be something one can suggest to framers and collectors over the phone. (MBC)
 5. **Pre-pasted Hinges:** Pre-pasted Insta-Hinges are available from Archival Products. They are expensive and require careful wetting for use. (They cannot be simply brushed or sprayed with water to work effectively. Must be thoroughly moistened by laying them out pasted side up on a wet blotter). Although the idea is basically sound, we have no experience with this new product and cannot recommend them. It is not yet known whether they provide adequate adhesion for use and according to the product literature, a fungicide is added to the paste.
- E. Pressure Sensitive Tapes:** Should never be applied to valuable objects for matting purposes. Even the recently developed tapes marketed as archival have not been proven over time and should not be used for hinging.

40.3.3 Blotters: Used as a work surface that affords protection to objects and frames and is easily replaced when soiled. Objects with friable media should have an interleaving sheet of glassine or silicone release paper when the object is placed face down. Also used to absorb moisture under hinge while brushing out adhesive, to blot moisture after applying hinges to water sensitive supports and for placement over hinges (separated by a non-sticking polyester interleaving layer), to enhance drying and ensure flatness after hinge application. For these uses, blotters are most convenient when cut to approximately 3"x 5" rectangles.

40.3.4 Release Paper: Silicone release paper, non-woven, spunbonded polyester web, polyester film, "Bakers" paper, Florists' waxed paper or silicon coated polyester film are

used to prevent a drying hinge from adhering to itself, to the object, or to blotters. Long fibers of polyester web may catch on paper edges.

"Bakers" paper is a very thin, coated paper, permeable to moisture **which** - unlike non-woven polyester - does not snag and which - unlike silicone release papers - is not hard and does not cockle. (MBC) "Florists" paper is a green waxed paper (waxed on one side only) which allows one to choose the side to control the rate of transmission of moisture. Cockling is less pronounced and invasive than silicone release paper. (JT) Cut interleaving into segments that fit easily under art or match the size of weights and blotters used for drying. Strips may be used which extend beyond the dimensions of the object so that interleaving may be easily removed after applied hinges have dried. Polyester film/web combinations may be used during application of a folded or v-hinge. When placed under the object with the polyester film against the object and the polyester web against the hinge, the film prevents any moisture from reaching the object while the hinge is drying.

40.3.5 Weights: Cast lead (usually 2 to 5 lb. ingots) and metal shot are the materials most frequently used for weight. Weights should be easy to grasp. Cast lead must be thoroughly covered to prevent contact with skin (or surfaces of objects). Cloth, felt, or bookbinders' buckram have been used for covering. Penny weights, film canisters filled with pennies or metal shot, are considered by some conservators to provide adequate weight over drying hinges. Marble slabs from trophy bases also make good weights, available at trophy stores. "Plexi-squares," 1/4 - 1/2 inch Plexiglas cut to fit under weights, are used to distribute weight uniformly.

40.3.6 Brushes:

- A. Flat edged synthetic bristles and natural bristle brushes:** For working out paste when diluting and for applying paste to hinges.
- B. Draftsman's brushes:** For cleaning work surfaces and frames.
- C. Hake brushes:** For removing specks and dust from mats' surfaces. (It is useful to label these brushes, "For Art Only.")
- D. Housepainters's Brushes:** Large brushes for cleaning out frames.

40.3.7. Manipulators

- A. Stainless steel microspatula:** For lifting corners of objects.
- B. Section lifter:** A stainless steel shovel-shaped instrument for turning under v-hinges. May be available from biology suppliers.
- C. Tweezers:** For grasping pasted hinges, etc.
- D. Bone folder:** For burnishing linen-tape spine of mats (a brayer can also be used for this.)

40.3.8 Matting Materials

- A. Ragboard, buffered:** Buffered cotton fiber board is usually referred to as Ragboard or Museum Board. It contains high grade cotton fibers from early cuttings from the plant or from new cotton rags and linters (generally 70% cotton fiber to 30% cotton linters) made alkaline with the addition of calcium carbonate. The pH can be

as high as 9.0. The hardness of the board is determined by the proportion of cotton linters. Most boards lighten in color considerably on exposure to unfiltered light, and most manufacturers have difficulty maintaining color stability. Color and pH may vary from shipment to shipment and must be monitored. Board with a higher proportion of cotton linters is harder surfaced, harder to cut, and has a greater tendency to warp. It has been noted that pH begins to drop after package is opened. (JT) Available in 2, 4, 6, and 8-ply thicknesses.

- B. **Ragboard or Photographic Board, unbuffered:** Contains cotton fibers and linters without added buffer. Unbuffered cotton fiber board is recommended for matting photographs and other objects composed of alkaline sensitive materials. (According to James Reilly of the Institute for Image Research, damage to photographs by alkaline matboard is only a theoretical assumption. The advantage of using non-alkaline matting materials is not invalidated but has not been proven. (MBC) Also available in 2, 4, 6, and 8-ply. Check pH carefully as shipments have been received with pH as high as 12.
- C. **Archival or Conservation Board:** May also be referred to as Museum Board. Composed of chemically purified wood pulp, either the alkaline sulfate or the acidic sulfite process. (Neither process yields 100% alpha cellulose. The bleached and purified sulfite product is 96% while the bleached sulfate process yield is 94% alpha cellulose. The rest is ash, lignin, beta and gamma cellulose and hemicelluloses.) These boards are buffered with 2-3% calcium carbonate. Also available in 2, 4, 6 and 8 ply. They are generally stiffer than ragboard and may support large items better.
- D. **2-ply Board:** Available in either rag or archival qualities, as described above. 2-ply board is an option when one chooses to hinge objects to an insert and for matting in certain cases.
- E. **Archival Paper:** For example, Permalife paper, composed of chemically purified wood pulp, either sulphate or sulphite process, buffered with calcium carbonate. May be used to make photo-corners or objects may be hinged to an archival paper insert, etc.
- F. **"Filled," "Newsfilled," "Chipboard":** Generally, mechanically processed but not chemically purified wood chips or recycled newsprint with an alkaline reserve faced with purified wood pulp papers of various colors (pasted on). Not recommended for matting objects of value.
- G. **Honey-comb Panels:** See 40.4.5. **Oversize.**

40.3.9 Cover Tissues: Fiber identification, elemental analysis and pH (by cold extraction) information were compiled from testing done on various papers considered for use as cover tissues at the National Gallery of Art. Abrasion testing for cover tissues specifically for photographic materials has been conducted by Maria Holden of the New York State Archives and will be published soon.

- A. **Buffered tissue:** Not translucent, chalky feel and look. Contains grass pulp and calcium carbonate.
- B. **Glassine:** A mixture of hard and softwoods with pH 6.9 and traces of iron impurities. Translucent. Acid treatments that transparentize the fibers may cause

later yellowing. Generally used but yellowing after a few years may indicate that it requires replacement.

According to Process Materials, their glassine is made without using acid. It is just beaten and calendered .

- C. **Silversafe:** 100 percent cotton fiber, pH 6.6 with traces of iron impurities. The smooth surfaced paper is less abrasive than other tissues and is non-buffered, thus recommended by the manufacturer for use on photographic material.
- D. **Unbuffered tissue:** An unbuffered tissue made from abaca fiber is being sold for use as a cover tissue on photographs. It has the advantages of being unbuffered, relatively transparent, smooth, although it is not dust proof and has not been tested for abrasiveness.
- E. **Silicone release:** For interleaving on slightly friable media. Composed of hard and soft wood fibers, pH 6.6. No coating material was detected in testing, however, silicone release paper has an undeniably greasy feel.

40.3.10 Cutting Tools and Aids

- A. **Mat cutters:** Horizontal models are most frequently used in conservation. Vertical model mat cutters are costly and are primarily for production work where hundreds of mats may be cut with the same opening.
 - 1. **Board shears:** Lever action cutters for trimming outside edges of matboard or cutting cover sheets, etc.
 - 2. **Bar type matcutters for bevels**
 - 3. **Hand held**
 - a. Knife
 - b. Matknife - utility knife
 - c. Scalpel
 - d. Commercial cutters such as Dexter, Exacto, Logan
 - 4. **Mechanical action:** automatic oval cutters
- B. **Trimmers**
 - 1. **Utility knife**
 - 2. **Scalpel**
- C. **Straight Edges**
 - 1. **Metal**
 - 2. **Rubber or cork backed**
 - 3. **Beveled:** For cutting beveled edge with hand held knife or for decorative work.
- D. **Cutting Surface**
 - 1. **Cardboard**
 - 2. **Plastic, self-healing cutting mats:** Not for cutting mats, will wear out quickly. For use under scalpels, etc.

40.3.11 Tape

- A. **Linen tape:** Water-activated, gummed linen tape is used to attach the window and additional sheets of ragboard, such as wrappers to the backboard.
- B. **Pressure-Sensitive Tapes with Rubber-Based Adhesives:** Pressure

sensitive tapes should never be applied to a paper object in matting and framing. Package sealing tape is used to seal the space between the frame and backboard. It has been noted that this tape is electrostatic and will leave marks on painted walls where frame is hung.(JT) This problem should be solved by using pads at the four corners of the frame to allow an air space between the frame and wall.

- C. **Pressure-Sensitive Tapes with Acrylic adhesives:** Again, pressure-sensitive tapes should never be applied to a paper object in matting and framing. However, pressure-sensitive tapes with acrylic adhesives such as 3M-415 Double-sided Tape, J-Lar Permacel, or 810 Magic Mending Tape have proven to be adequately stable for use in mat construction, taping frame rabbets, sealing mat packages, attaching photo-corners, etc. Although some of the adhesive certainly penetrates paper fibers, empirically, acrylic adhesives have not been observed to degrade as rubber-based adhesives. They do not appear to creep or transparentize paper to which they are attached.
- D. **Paper tapes:** Again, formulations of commercial products may change without notice. Such products are not recommended for use in direct contact with objects. Acid Free Paper tape, available from Light Impressions, may be used on matting materials, e.g. for taping down photo corners or taping mats to mounts which will be framed, thus not requiring the strength of linen tape.(MBC)
Water-activated gummed kraft paper tape may be used for sealing backs of frames. Filmoplast P-90: According to the manufacturer made of a polyacrylate in a water dispersion (adhesive) and bleached wood fiber paper (carrier). Analysis has confirmed the presence of polyacrylate and suggests that plasticizers, tackifiers and fillers are also used. (MM) The manufacturer claims that the adhesive can be removed with water. However, empirically, the adhesive has been known to yellow and may become more difficult to remove from paper supports over time. Filmoplast P-90 is used to attach 2-ply inserts or photo-corners to backings, etc.
- E. **Metal foil and paper tapes:** Pressure sensitive tapes sold for frame sealing, such as P/S Frame sealing tape from Archival Aids. Carrier is foil and paper with acrylic adhesive on foil side. The foil acts as a moisture barrier.
- F. **Pressure Sensitive Cloth Tapes:** See Filmoplast P-90 above. Filmoplast SH may be used to tape the spine between the window mat and backing. It requires burnishing only, thus speeds matting.

40.3.12 Measuring Tools

- A. **Tape measures:** Hook end is more likely to damage edges of an object than loop end. Dressmakers's plastic or cloth tapes may be safer for measuring objects though not accurate enough for mat measurements.
- B. **Centering rulers**
- C. **Carpenter's scribes**
- D. **Carpenter's squares**

40.3.13 Mat decorating tools

- A. **Pen and ink, watercolor, gouache, and acrylic**
- B. **Ruling pen and ink**

- C. Gold paint
- D. Gold foil
- E. Brushes
- F. Straight edges
- G. **Fabrics:** Silk, linen, velvet, and synthetics. High acidity of silk and complications from unknown finishing materials on linen, velvet, or synthetics require that such decorated mats be lined with 2-ply ragboard to separate from the object.
- H. Tea Chest Paper

40.3.14 Moldings

A. Molding Selection

Frames with strainers are good for rotating collections. Also, standardized sizes are very practical for rotating objects for exhibition. Period frames and artists's frames should be recycled. (See **40.4.4 Adapting Old Frames.**)

1. Traditional

a. Graphic depth

- 1) Depth: Shallow rabbet.
- 2) Strength: Weak, may need strainer, no stitching (the use of brads to strengthen the frame by pushing them through a backing) allowed.
- 3) Aesthetics: No shadows.

b. Painting depth (for more separation)

- 1) Depth: Deep rabbet.
- 2) Strength: Strong, no strainer needed.
- 3) Aesthetics: Casts shadows.

2. Contemporary

- a. Wood
 - 1) Welded.
 - 2) Sectional.
- b. Metal

40.3.15 Glazing materials

- A. **Glass:** Least expensive glazing material; low UV- filtering capacity; edges may be sanded or dulled for safety; non-static; planar stability (does not bend or waffle) but potential for breakage requires careful handling and taping for travel; can be stored standing upright or flat. Old glass can spontaneously shatter. Picture glass may be considered too thin for use in framing and general handling. Single strength glass, may be used up to 30" x 40" Above 30" x 40", double strength glass should be used. For very large works, safety glass or laminated glass may be used. This is tempered so that instead of splintering, it breaks up like a car windshield. It is very heavy and very hard to cut. However, it can be purchased cut to true size of the frame and then tempered. (MBC)
- B. **Acrylic Sheeting (Plexiglas):** More expensive than glass; non-breakable; UF-4 and OP-2 remove approximately 90% of the UV range and do not have a yellow

cast. UF-3 removes 97% of the UV range, has a slight yellow cast and is more expensive. A common misunderstanding about UV-filtering acrylic is that it should be changed. In fact, as it ages and becomes more yellow, it becomes more effective. (MHE)

Plexiglas contracts and expands with changes in temperature and RH. (One must make allowances for this in measuring to fit frames). It is lighter than glass, scratches more easily and is clouded by solvents. Also available with an abrasion resistant coating (S.A.R.).

In larger sizes, one must use thicker Plexiglas to minimize bowing (this is less of a problem with glass). Because of static charge which builds up despite initial anti-static cleaning, Plexiglas should not be used on friable media such as powdery pastel, soft graphite, charcoal, flaking paint. Plexiglas may be used on pastel and charcoal at the discretion of a conservator. In individual cases sufficient space may be allowed between the media and the Plexiglas such that the media will not be in danger.

- C. **Denglas:** Expensive; filters UV somewhat better than glass (about 20%); has been problematic to tape surface for travel because removal of tape with a razor blade scrapes surface, however, alcohol can be used to remove residual adhesive; slight purplish reflection. Denglas may diffuse the crispness of the image.
- D. **Gedolln:** A non-glare, UV-filtering acrylic sheeting called Gedolin is also on the market. It is manufactured in Europe and very expensive. Because it is heat-treated, it is less flexible than regular acrylic sheeting and can break more easily on impact. Tends to look yellow with purple reflections.
- E. **Safety Denglas:** Expensive; available in limited precut sizes not larger than 30 x 40 inches (this size costs approximately \$1000.00); does not require taping; must be ordered to size much in advance and precut sizes may not be exact.
- F. **Non-glare glass:** In order for the non-glare effect to work, the glass must be placed directly against the object; therefore, non-glare glass is not recommended for paper objects.

40.3.16 Frame Backing Boards

(Also see 40.5.6 Precautions for uncontrolled environments for additional comments on backings and relative humidity.)

- A. **Acid-free corrugated board:** this board is available in 1/8" (single ply) and 1/4" (double ply) thicknesses in white and blue-grey. In uncontrolled or fluctuating environments, has been observed to expand more than non-acid free cardboards. In one case, a framed piece, approximately 30 x 40 inches, had pushed itself from the wall when the backing board swelled and bowed out. (JT)
Double corrugated board has a tendency to warp. If additional thickness is required, single sheets should be laminated cross-grain with Scotch 415 double-sided tape. (EKS)
A brown corrugated cardboard, is also being marketed as "Acidfree" but it is not lignin free.)
- B. **Polystyrene core boards (Fome core):** Some are marketed as acid-free, composed of a polystyrene core with plastic coating (no paper). Others are paper

faced and have been observed to yellow over a few months from degradation of the core material. The same off-gassing which causes the facing papers to yellow is presumably occurring with the so-called "acid-free" variety, but the plastic facing doesn't yellow as does the paper. For this reason, these boards are not recommended for permanently mounting (direct contact with) valuable objects, however, may be used as an additional backing for framed objects for travel.

- C. **Masonite:** Still used for backing frames for travel; however, should be reevaluated in light of recent research on the effects of formaldehyde emissions from prepared wood boards on paper.

40.3.17 Tools

A. Unframing

1. **Needle nose plier**
2. **Diagonal pliers**
3. **Screw drivers**
4. **Spatula:** To pry backing board out and cut through excess glue around backing boards.
5. **Supports**
6. **Shim:** To rotate pliers against when removing brads/nails.

B. Framing

1. **Brads, glazing points:** Brads are preferable, glazing points are not appropriate for framing.
2. **Brad applicators:** Brad pushers and fitting tools which insert brads using compression are recommended. Impact guns are not recommended for inserting brads because they may jar the object.
3. **Turn buttons:** Screwed onto the reverse of shallow or antique frames for holding matted package in place.
4. **Chamols, cloths**
5. **Lint-free Kimwipes**
6. **Vacuum Cleaners:** Mini vacuum cleaners, as used for computers, are useful for cleaning out debris caught in old frames. A regular size vacuum cleaner with an attachment fitted with a soft bristled brush or covered with soft netting may also be used.
7. **Plexiglas Cleaner:** Anti-static solution, Like-Majic.
8. **Glass Cutter**
9. **Plexiglas Cutter**

40.3.18 Dust Covers

- A. **Kraft paper:** Adhered to molding with Jade 403 or Elvace (avoid allowing adhesive to flow into spaces between backing and frame) or 3 M double-sided 415 tape (will not flow during application); it is not recommended to dampen paper and stretch it on the frame. A disadvantage when this is used for permanent framing is that old Kraft paper causes a lot of dust during unframing.
- B. **Permalife or Bristol**
- C. **Tyvek:** Extruded polyethylene (Dupont). Very strong, apply as for Kraft paper.

40.3.19 Equipment and techniques for hanging

A. Wires, hooks, mirror plates

B. Spacing from wall: It is recommended to allow air space behind the frame to discourage moisture buildup which may encourage mold growth and to distance the frame from problematic paints or wall materials. Purchased vinyl bumpers (available with tack-on or pressure sensitive adhesive or special screws and screw driver required) felt or cork may be attached at four corners.

C. Security hangers: Bolted to wall.

40.4 Treatment Variations

40.4.1 Unframing and unmatting paper objects

Consult with the owner or curator about parts of the existing housing which must be retained for historical reasons before removing objects from frames. Save old, wavy glass unless it is "weeping". Exhibition labels on reverse of backings may be considered part of an object's provenance and should be properly filed or encapsulated on reverse of new mat. Adaptations for rematting and reusing existing mats and frames are discussed in 40.5.5.

A. Unframing Procedure

1. Photograph to document condition on receipt. Take detail shots of any interesting characteristics or peculiar observations. Continue to photograph significant characteristics/observations discovered during unframing (Optional). One may also wish to examine and record observations about the frame and object on examination forms. Elaborate on these observations as unframing continues.
2. Anticipate potential problems which may include any of the following:
 - a. Object stuck to glazing: This is indicated by a glossiness or intensification of the ink or colors, generally in a discrete area. Could result in skinning when glass is removed. Acrylic medium has been known to stick to Plexiglas.
 - b. Object askew or overlapping window edge: this may indicate that the object is not adhered. Could result in tearing of the object during unframing.
 - c. Object buckled: May indicate that the object is loosely sandwiched into the window mat rather than adhered in any way. Object too flat may indicate it is dry mounted to a brittle board or possibly directly to the backing board.
 - d. Glass warped or cracked: This could prove dangerous both to the object and staff during unframing.

- e. Frame joints loose: This could cause the frame to be unstable during and after unframing.
 - f. Object attached to window mat rather than to backing.
 - g. Backboard or object stuck to sides of rabbet, by friction or with adhesive which has seeped in from applying a Kraft paper backing.
 - h. Degraded backboards, papers, etc.
 - i. Object loose from hinges.
 - j. Frame too tight.
 - k. Object taped to window mat and backmat.
 - l. Object folded or wrapped around backboard.
3. Turn the framed object face down on a padded surface. Velvet (HP); open meshed polyethylene, carpet, thick blotters; expanded, closed cell polyethylene (can be wiped clean (MBC), and bubble wrap (EKS) have been recommended. For objects with friable or fragile media or for large works, one should work with the object supported vertically or almost vertically, for example, working on an easel. This keeps the object at a vertical, and allows for observing the front to catch any problems as unframing proceeds. The easel may be fitted with padding, such as polyethylene covered felt.
 4. Remove the hardware and wire and place at a safe distance from the object. Discard old wire, if approved.
 5. Clean the back of the frame by dusting or vacuuming and mark the frame edge or back with an easily removable identifying label, if required. Indicate top of frame if unclear.
 6. Record any labels or notations found on the back of the frame or backing paper.
 7. Remove the backing paper by carefully tearing it away from center to outside in order to thin where it is glued at edge, and discard if approved.
 8. Remove the retaining devices (nails, brads, or diamond-shaped wedges) by gently loosening them with sideways tapping and pulling towards the center of the frame or using a shim with diagonal or needle-nose pliers to gently rotate retaining devices out. (Removing with other tools, such as screwdrivers, may cause rough handling.)

9. Check that no retaining devices or obstacles remain hidden below the exposed backing by closely examining the space between the backing edges and the inner rim of the frame. Run a thin spatula or razor blade held vertically at rabet around rabet edge.

10. Determine whether glass is free of the frame rabet. Reach under the glass/Plexiglas front and slightly press it with your fingers. Remove the contents of the frame in one of the following ways:
 - a. If the glass is not attached to the rabet, and the object is fairly small (less than 24" x 36"):
 - 1) Continue pushing up on the glass with hands at diagonal corners. Allow the freed contents to rest on the back edges of the frame while you reach behind the frame, one hand at a time, to get a new grasp on the separated package. Then place the contents, still face down, on a clean surface.
 - 2) Determine which layer of backing materials is in direct contact with the object.
 - 3) Carefully lift off any backing materials which are not attached to the reverse of the picture. Gently dust the back.
 - 4) Cover the back with a rigid support of acid-free board and turn the contents, including the glass, face-up.
 - 5) Carefully lift the glass up off the object, making sure the paper is in no place stuck to the glass. Place the glass back in the frame and secure it within. A piece of rigid board should be included for protection against breakage and the frame should be stored.
 - b. If the glass is not attached to the rabet, and the object is large or heavy:
 - 1) Cover the back with a rigid board, invert the frame, and lift the frame away.
 - 2) Repeat step 5) above
 - c. If the glass is attached to the rabet:
 - 1) Cover the back of the frame with rigid board.
 - 2) Stand the frame on one of its long edges on padding.
 - 3) Tilt the whole package backward until the frame contents become loose and fall against the rigid board supported by a hand.
 - 4) Ease the tilted contents on the board down onto the table surface.
 - 5) Store the frame and glass.

11. Place object in folder or other appropriate container and remove from framing area. Boxes may be required to protect surfaces with friable or flaking media. Objects stuck to glass, etc. and requiring further handling should be covered or wrapped.

B. Removing Former Matting Materials

(See 24. Backing Removal; 15. Hinge, Paper and Adhesive Removal)

40.4.2 Average size, media and support without significant problems

A. Hinging Requirements:

1. Choice of paper

- a. **Weight:** Heavy enough to support the object, but not heavier than the object paper. Too heavy a hinge paper may emboss the object and may cause the object rather than the hinge to give way or tear if any stress is encountered.
- b. **Thickness:** Thickness and stiffness of hinge should never be greater than that of the object.
- c. **Grain direction:** Use hinges with the grain perpendicular to top edge of the object to provide strength for hanging. In handmade Japanese papers, the grain runs parallel to chain lines. In machine made papers, grain runs parallel to machine direction.
- d. **Strength:** In Japanese papers, the length of the fiber, degree of beating and type of cooking and chemical treatment affect strength of paper regardless of weight or thickness. Ease of tear in a dry sheet and separation of fibers in a wet sheet when pulled give a rough indication of strength. Thus it is possible to select a strong thin paper or a weak heavy paper to match the qualities of the object. (BF)

2. Hinge size

- a. **Bar Hinge:** As little as 3/4 - 1 1/2" high, length varies according to the size of the object from 1/2" to as much as 4 1/2". Bar hinges are applied with the long edge attached, in order to cover adequate surface area without going far into the object.
- b. **Strip Hinge:** As little as 1/2" to 1 1/2" wide, 1" to 2 1/2" long. The overall size depends on the size of the object. The strip hinge is applied vertically, extending further into the object to cover adequate surface area.

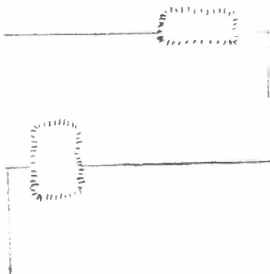

3. Cutting Hinges and Crossbars

- a. **Cut edges:** Prepared by running a scalpel along a straight edge. Edges of crossbars for pendant hinges may be cut straight. Cut edges are generally not applied to the object as the hard edge is often detectable from the front. Grain of crossbars should run parallel to long sides.
- b. **Feathered edges:** Using a straight edge parallel to the grain direction of the Japanese tissue, a lightly feathered edge may be made by tearing directly against the edge or scoring with a dissecting needle and then tearing. A longer fibered edge is made by water tearing. A brush or ruling pen is used to score the paper with a thin line of deionized water along a straight edge, running a bone folder along the line to define it and tearing apart. Feathered edges can also be made using a pattern cutting wheel available from fabric stores. (JT)
- c. **Hinge strips:** Generally, a strip of hinges is prepared by cutting or water tearing parallel to the chain lines of the Japanese tissue. This creates a strip

Hinge strips may also be prepared by cutting or water tearing perpendicular to the chain lines in the Japanese tissue. This results in strips of a standard hinge height. Hinge width can then be varied as desired by applying a bead of water and thumb-tearing against the weaker orientation of the paper.

4. Pasting

The dilution of paste mixtures and amount of paste applied should be controlled to accommodate a number of factors. Thin paste does not mean weak paste. Thin paste will dry faster and is less likely to cause staining or change translucency of an object. Thick paste may dry stiff or cause contraction and buckling of the object. Thick paste dries more slowly and will have more time to cause staining or change translucency of an object. Thick paste is hard to remove on soft paper. (BF) On the other hand, thick, dry paste will not penetrate as deeply into most papers and may be easier to remove.

Use blotter or matboard scraps under Japanese tissue to absorb moisture.

Paste the consistency of yogurt is generally appropriate for many types of objects. If paste of thinner consistency is required, use matboard as a pasting surface. Paste may be applied in both directions in order to distribute it evenly and remove excess or in grain direction only to avoid stretching the Japanese tissue while wet.

Pasted side of hinge may be lightly blotted before applying to objects which are extremely sensitive to moisture, such as some modern papers. When paste no longer glistens, the hinge is dry enough to apply. It is sometimes recommended to leave about 1/4" of the bottom of the hinge unpasted to facilitate easier removal; however, when using an extremely narrow hinge because of water sensitivity of the object, do not leave this bottom margin. In many cases, the fibrous edge may be used to hold the object. (JT)

Hinge preparation may be speeded by overlapping several hinge rectangles, leaving only that part of the hinge uncovered that is to be pasted. A Mylar mask may be used to cover the portion of the pendant hinge which will later be pasted to the backboard.

5. Number and location of hinges

a. Top hinges: Traditionally, conservators have recommended that as few hinges as possible be used; however, center sagging and corner draping on very large or very thin papers have led to modifications of this.

Attention should be paid to even support across the entire top of the object. Enough hinges should be applied to evenly distribute weight without curtaining.

Generally, two or more hinges along the top edge allow examination of the reverse. Hinges should not be placed directly at corners as this hampers easy rotation and corners may be caught. Allowing some distance from the corners also alleviates the problems of center curtaining along the top edge. A rule of thumb distance of approximately half the hinge width from

the corner seems to work. If possible, hinges should not be placed behind areas of sensitive media, i.e. water soluble inks, gouache, high impasto areas, etc., to facilitate removal and prevent damage to media.

- b. Side hinges:** Left side hinging was formerly used when prints were mounted in albums. Some print collections continued to use this method for matting, considering it an advantage for handling, allowing the mat to open and the object to be turned as a page in a book for study of the reverse. However, even when overmatted, side hinges do not adequately support the object against downward pull.
Side hinges are now used as restraining hinges for large and floated objects to prevent forward movement of the bottom or sides of framed objects due to static attraction to Plexiglas. For objects measuring more than 16" x 20", side hinges are recommended to prevent slippage in storage. Side hinges may prevent slippage during travel by continuing to hold the object if top hinges shear due to impact. When hinges are used in addition to the top edge, location should be noted on backmat.
- c. Bottom hinges:** Tend to distort the bottom edge and cause the object to cast a scalloped shadow when exhibited. They are not useful if other hinges fail. However, most conservators continue to recommend loosely adhered bottom hinges to restrain the bottom edge from drifting toward Plexiglas, due to static attraction, and for travel. By not completely adhering the hinges to the work along the hinge fold, the bottom edge will still have a natural, draped appearance and will be able to move with changes in humidity. (DT,FZ) As for side hinges, location of hinges on the bottom edge should be noted on the backing.

6. Placement

One rule of thumb is to attach 1/3 of the hinge to the object, 2/3 to the backing. Hinges are placed at the edges of the object except for deckle edges which require hinges to be placed below or slightly in from the edge.

- a. Strip hinges:** The smaller portion of the hinge, approximately 1/2 to 1", is attached to the object. The larger portion of the hinge is attached to the backing.
- b. Bar hinges:** A very small portion of the long edge of a bar hinge is attached to the object, approximately 1/4 to 1/2". The larger portion is attached to the backing.

7. Blotting/Drying

For objects that are very sensitive to moisture, hinges may be dried topically immediately after application with moderate (gentle) pressure and blotters, blotting for 1 or 2 seconds and changing blotters up to 10 or 20 times.

8. Weighting

Place non-sticking interleaving material over wet hinge, 1/4 or 1/2 inch Plexiglas square to distribute weight evenly, and weight. Hinges must be dried under weight for a minimum of four hours. (Many conservatorshinge objects at the

end of the day and allow them to dry overnight.)

Alternatively, place non-sticking interleaving materials over wet hinge, blotter and cushioned weight. Add an extra thick felt layer to weights for the purpose. If hinges have been dried topically as directed above, they may be adequately dry after one hour.

9. Attachment

- a. **To 2-ply insert or archival paper:** This method is preferred for drawings or fragile supports as it reduces the numbers of times the object will undergo hinging and hinge removal during its lifetime. The object may be removed from a storage mat and placed into an exhibition mat without cutting or removing hinges. Final adjustments on the position of the object in the window can also be made when the 2-ply is attached to the backboard. This attachment allows for general handling without touching the media of images that extend to edges.
- b. **To 4-ply backing:** May necessitate removal of hinges and replacing backboards each time a change of mat is required.

10. Hinge type

a. For Overmatting:

- 1) **Pendant or Hanging Hinge:** All purpose, strong hinge for overmatted objects.
 - a) **Attachment to Object:**
 - (1) Paste only the portion to be attached to the object.
 - (2) Place the pasted portion of the hinge on the back of the object and weight
 - b) **Attachment to backing:**
 - (1) When the hinges on the object are dry, place the object in the assembled mat with the image correctly positioned in the window opening. Hold it in place with light weight in a non-image area.
 - (2) Turn and fold the hinge forward over a piece of blotter polyester film, paste the reverse of the hinge, and turn the blotter or film support over, pressing and smoothing the hinge onto the backing. Weight to dry.
 - c) **One Step Attachment to Object and Backing:**
 - (1) Position the object face up on the backing with release paper directly under the top edge at hinge position. Weight in place in a non-image area.
 - (2) Using a waste paper mask, paste out only the lower portion of the hinge to be attached to the object. Discard waste paper.
 - (3) Gently lift the top edge of the object and slip the pasted portion of the hinge under the edge. Release the object.
 - (4) Immediately fold the unpasted portion of the hinge forward, support it on a blotter or a piece of mylar and paste out.

- (5) Turn the blotter or mylar over, pressing and smoothing the hinge onto the backing.
- (6) Arrange release paper to cover both parts of the hinge. Use blotters or release paper over the exposed part of the hinge to equal the thickness of the object so that weight will be equally distributed while drying. Cover with blotter, Plexiglas square and weight.
- (7) Repeat for other hinge

2) Pendant with crossbar: Strongest hinge. Good for large objects. The hinges attached to the object are never pasted directly to the backboard. They are, therefore, able to move slightly as the object expands and contracts in response to fluctuations in the environment and thus reduce the stress that is placed on the artwork. Crossbars should be cut larger than hinges by 1/4" on all sides. The crossbars should be centered over the hinges laterally, at a distance from the top edge of the object that is equal to or slightly greater than the thickness of the object. The crossbars are correctly placed if the object is free to flex on its hinges so that the verso is accessible for examination and the object is held in the mat securely enough that it will not shift if the frame is jarred.

a) Attachment to object: Follow instructions for Pendant or Hanging Hinge.

b) Attachment to backing:

- (1) When the hinges on the object are dry, place the object in the assembled mat with the image correctly positioned in the window. Hold in place with light weight in a non-image area.
- (2) Apply paste to the entire surface of the Japanese tissue crossbars. With tweezers, place them on the unpasted, free ends of the hinges and on the backboard. Rub with a bone folder, dry and weight as above.

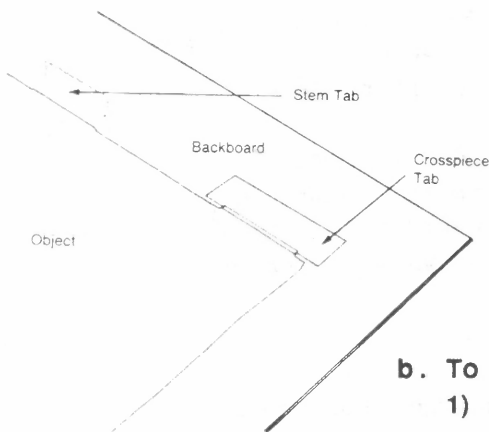

b. To Float:

1) Folded or v-hinge: Quickest hinge but can slip. Pasting and attachment to the object and backing may be done in separate steps to allow for careful application of the portion to be attached to the object and wetter, more heavy pasting of the portion to be attached to the backing.

Alternatively, the folded hinge may be attached in one step. It may be safer for the object not to be inverted. For bottom and side folded hinges, to avoid a constrained appearance and to prevent draws or distortion of the paper support due to environmental fluctuations, do not adhere the hinges completely to the object and backing along the length of the hinge fold. This will allow for a looser, more natural appearance, as if no side or bottom hinges have been applied. (DT,FZ)

a) Attachment to object:

- (1) Paste only the portion to be attached to the object.

- (2) Place the pasted portion of the hinge on the back of the object, blot (as required), and weight.

b) Attachment to backing:

- (1) Position object correctly in completed mat. Weight lightly in place.
- (2) Place interleaving beneath object at hinges.
- (3) Fold hinges to create horizontal crease at edge of object.
- (4) With hinge extended, place blotter under portion of hinge to be pasted to the backboard. Paste out.
- (5) Remove blotter.
- (6) Place flat of section lifter or similar shovel-shaped tool (with a flat end wider than a micro-spatula) at the top of the pasted hinge. Lift object and interleaving slightly while scooping the section lifter under the object.
- (7) Press object, interleaving, and hinge to backboard.
- (8) Weight.

2) Folded or V-hinge - One Step Application:

- (1) Position the object on the backing. Weight in a non-design area.
- (2) Fold the hinge in the proportions to be attached to the object and the backing (about 1/3 to the object, 2/3 to the backing.)
- (3) On blotter or matboard paste the entire hinge
- (4) Using tweezers, fold the hinge around a piece of release paper.
- (5) Gently lift the top edge of the object, place the folded of the object, place the folded hinge and release paper under the object with the fold resting directly at the edge of the object.
- (6) Immediately weight with Plexiglas square anweight, and allow to dry.

B. Matting Requirements

- 1. Choice of matboard thickness:** Separation of the object from the glazing is the most important function of matboard. Contact with glazing can cause ferrotyping, staining, and the further damage which may result from condensation (e.g. mold growth and adhesion of the artwork to glazing material).

Grain, or machine direction, of matboard should run parallel to the longer dimensions of each piece. This makes the board more rigid.

- a. 2-ply:** 2-ply may be used for matting small to average size artifacts or prints for storage to save valuable storage space. 2-ply flexes easily and must have additional support when handled. A 2-ply mat is usually not aesthetically appealing for display and does not provide adequate spacing between the object and glazing. When stacked in storage, 2-ply may not provide adequate space or rigid enough support to prevent mats from sagging into the space created by windows. Hinges may

loosen as an object is handled on a non-rigid support. A 2-ply mat supported by a 4-ply backboard is a more secure option for storage if space is limited. It is not advisable to use a 4-ply window mat with a 2-ply backing.

- b. **4-ply:** Except for large or cockled objects or objects with friable media (soft pencil, charcoal, pastel), 4-ply board generally allows adequate space between the surface of an object and glazing to prevent the object from touching glazing.
- c. **6 or 8-ply:** A depth of 6 or 8-ply may be required to prevent large or cockled works from touching Plexiglas which tends to bow inward in large sizes. (Also see 40.4.3 Thick or Cockled Supports)

2. Choice of Matboard Color

The choice of matboard color for display may be determined by availability. Ragboards tend to be fairly limited in color, available in a range of white, cream, grey, beige and pastel shades. Conservation board is available in more colors.

The choice of color and the use of decorative mats, such as "French" watercolored or fabric covered mats, may enhance an object. The proper color choice may minimize the discoloration of objects in poor condition.

3. Window Preparation

- a. **Aesthetics for placing opening:** The width of the matboard borders is determined by various factors. For safe storage, the object should have at least 2" around it on all sides. Maximum width is determined by the object size. The bottom border is generally wider than the top for visual balance. The minimum widths between two or more objects matted in the same window is 1/2". If cut less than 1/2", the matboard is weak and floppy, especially at the corners where horizontal and vertical cuts may overlap if not cut precisely. (HP)

Very small objects may be placed higher in the mat, and small, horizontal objects may be best presented in a vertical rather than a horizontal frame.

- b. **Methods for calculating opening:**

1) **Method 1:** The Library of Congress method uses sheets of frosted mylar prepared for this purpose. The top sheet is imprinted with a fine grid with lines spaced at 1/8" intervals. On the bottom sheet, standard mat sizes have been outlined. The two sheets are welded together (using a heat welder). This method is safe for prints and other non-friable media.

- a) Slip the object under the top sheet of mylar.
- b) Align the object in one of the standard sizes outlined in the lower sheet. Using the grid pattern, position the object exactly as desired within the standard size. Weight in place.
- c) Using soft pencil on the top mylar sheet, mark the exact locations for the four corners of the window.
- d) Remove the object.

- e) Place a standard size sheet of matboard under the frosted mylar sheet. align with the corresponding outline.
- f) Using a needle, prick the exact location for the window corners through the mylar to the matboard sheet.
- g) Remove the matboard. Use pencil to make the pinpricks more visible. The window mat is ready for cutting from the back.

2) Method 2:

Use a carpenter's scribe (with the metal point replaced with a piece of pencil lead) to both mark and compute openings in mats with standard outside dimensions. This process is best illustrated by an example. Where the width of the mat is A and the width of the opening is Bc/d, first find A-B and set the cursor of the carpenter's scribe at A-B/2. This represents the width of the mat side before the fraction c/d has been factored in. Next move the cursor in toward the marking point by half of that fraction. (This way, half of the fraction will be accounted for on each side.) (Example: Where the outside measure of the board is 14" and the opening is 8 3/4". The cursor is first set at $14 - 8/2 = 3$. Then it is moved in $3/16$ " to account for the fraction and is ready for marking.

3) Method 3:

Measure the height and width of the design that will appear in the window. Add 1/2 inch to the height and width of the entire piece if the object is to be floated. Subtract the horizontal measure of the window from the mat's overall horizontal measure. Divide this by two. Repeat for the vertical measurements. If the lower margin is to be wider for visual effect, add between 1/4" to 1" to the lower margin and subtract the same amount from the upper margin. (MHE)

- c. **Overmatting:** Inside dimensions of window are slightly smaller than artwork. Minimum overlap is 1/8". Overmatting better supports objects. It may also be useful to hide discoloration from former matting. Consider signatures, platemarks, etc. when measuring.
- d. **Floating:** Inside dimensions of window are slightly larger than object, never closer than 1/8" to object edge. For drawings which go to the edge, fragments, modern or contemporary works of art, objects with uneven edges, etc.

4. Cutting Window

Windows may be cut straight or beveled at a 45°-60° angle and cut beyond corner 1/8". Once cut, the inside edge that will be in contact with the object should be lightly sanded or blunted with a bone folder to prevent damage.

5. Cutting Backing

The grain must be parallel to the length of the window.

Dimensions may be standard, for example the Library of Congress uses 14 x 18, 20 x 24, 22 x 28, 28 x 40" as its standard sizes for storage and framing. Standard sizes may be ordered precut for an additional charge. If no standard sizes are used,

backing is cut same size as window mat. Size must allow that the object will be no less than 2" from the outside edge of the matboard.

- 6. Assembling the Mat:** One inch wide gummed linen tape or pressure sensitive Filmoplast SH are used to attach the window mat to the backboard, on a long side. If the object width is greater than its height, the tape is attached at the top. Usually, the tape is attached at the left edge so that the mat will open like a book. The object should not touch the linen strip at the spine of mat. Generally, linen tape is preferred for long-term use. Filmoplast SH is useful for its speed of application (does not require weighting and drying) and may be chosen for temporary mats.

a. Single window mat: For storage or display. For storage, insert an interleaving sheet.

- 1) Position and weight prepared window and backboard.
- 2) Cut, moisten, and apply linen tape. Tape should not be pulled when applied as this will tend to warp the matboard upon drying. When wet, the tape should simply be dropped in place.
- 3) Score the tape by running a bonefolder along the joint. This allows for a more flexible spine. Burnish.
- 4) Apply weight to dry. Alternatively, burnishing adequately adheres linen tape to the mat without weighting. Apply tape, burnish, close mat, run heel of hand along spine to adhere, open and close the mat several times so that it will be flexible and proceed with the matting. (MBC)

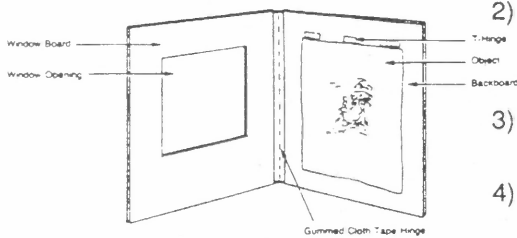

b. Double Window Mat: A double window mat is used at the Metropolitan Museum of Art for objects which are frequently handled in their mats for study and may be exhibited often. The second window may be lined with polyester film so that the image is easily seen. Glassine may be inserted between the two windows to prevent static attraction of the polyester (for media where this is a problem). The top window may be folded back, exposing the clean second window for display. Double windows provide more space above each matted object and protect surfaces from being pressed in a stack.

- 1) Prepare three sheets of 4-ply ragboard of desired or standard size.
- 2) Measure and cut identical sized windows in two sheets as determined by the object size.
- 3) Place the backings and outer (storage) window face down on the working surface. Leave approximately 1/8" between the edges of the two boards or a space equal to the thickness of a sheet of 4-ply.
- 4) Adhere the two boards using one inch wide linen tape as usual. The tape will be slack across the space between the two boards. This space will accommodate the inner display window.
- 5) With the storage window mat open, set the second window on top of (inside) the storage window and align the inside edge with the left edge of the backing mat. There should be no space between this window and the backing.

- 6) Tape the inner window to the backing using 1" wide linen tape. (The inner window will be out of plane with the backing mat by one 4-ply thickness. However, the tape can fit easily around this difference.) Burnish and dry as usual.

C. Glazing Requirements

To ensure the safety and condition of the object, glazing must never rest directly on the paper object's surface. Wherever there is contact between the paper and glazing material, condensation can occur, potentially disfiguring and damaging the object and encouraging mold growth.

1. **Selection:** Depends on the friability of media and the size of the object.
Glass and Plexiglas should never be tight in a frame. Wood can swell and cause glass to break. Metal frames can also shift and break glass. Plexiglas and glass expand due to heat such as may be caused by display lighting. A tight fitting frame causes Plexiglas to bow.
2. **Preparation:** To split a large piece of glass, score it with a glass cutter and lay a metal straight edge under the cut. Tap the edge hard at the score line and twist the cut open. Wear goggles and look away. Always dull the edges of the glass with a sharpening stone.
Cut Plexiglas using a Plexiglas cutter. Light scuffs on Plexiglas can be taken out by polishing first with a kneaded eraser, then with a Plexiglas scratch remover and finally with a Plexiglas polish. Use a diaper cloth for the scratch remover and polishing.
3. **Cleaning:** One should be cautious about using glass and Plexiglas cleaners around matting materials. The blue coloring in these cleaners are strong dyes. Do not use such cleaners around objects.

D. Framing Requirements

1. **Selection of Molding**
2. **Preparation of Molding:** Frame molding is cut on a mitre box. Splined corners on hardwood frames are the strongest but the workmanship makes them costly. Another method to strengthen frames is to countersink screws at corners perpendicular to the mitred edge. If the frame is not wide enough for this method, frames can also be attached by sinking a screw or nailing through the mitred ends at the corners of the top and bottom edges. Fill the holes with "fake wood" made from sawdust and Elvace.

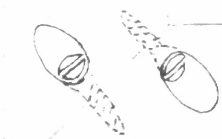

E. Assembling Mat, Glazing, and Frame

1. Work on a smooth soft surface or material (preferably velvet) to protect object and frame from abrasion.

2. Clean Plexiglas with cleaner and a relatively lint free cloth or tissue. Leave thin film of cleaner on both sides of the Plexiglas. It will dry by evaporation rather than by rubbing, lessening likelihood of a new build up of static charge.
3. Dust front and back of mat with a clean, soft brush. (Leave cover tissue inside mat to protect face of art object).
4. Pick up Plexiglas by its edges and turn it over onto the mat (like closing a book).
5. Check for buildup of static charge. Grasp Plexiglas and window by outer edges (held tightly together), and lift, opening the mat slightly. If the tissue lifts as well, a static charge has developed again. Reclean the Plexiglas. If no charge has developed continue to frame.
6. Remove cover tissue by gently lifting it up and off the face of the object and out of the mat.
7. Assemble frame, Plexiglas, and mat. Take frame into hands. Place it over the already assembled Plexiglas, mat, and object. "Lift" the object package up into the frame, and turn the entire package over. (Note: During the entire framing process the object is always oriented so that its hinges are on top as it is turned.)
8. Store tissue between the rag backmat and outer backboard. This is done for the sake of convenience and is also particularly useful when handling objects from other institutions as it keeps their cover tissues together with their objects.
9. Place protective backboard of acid-free cardboard over mat.
In order to ease later removal of tape from the backboard, tape a margin of package sealing tape to the backboard. This way, the tape used to seal the frame to the backboard can seal to itself and backboards can be reused without skinning.
10. Insert four brads (one in the midpoint of each side of the frame) to stabilize the package. As brads are inserted light to moderate pressure is exerted downwards (more with Plexiglas than with glass glazing) to help seal the edges and further stabilize the package. Brads are inserted with a nail injector, an "expert framing tool" or by pushing with the flat of diagonal pliers or a bent putty knife against the frame. Tack hammers are not desirable because they will jar the art object.
11. Check the face of the framed object to ensure that its fit is correct and that image and mat and glazing remain clean. This should be done throughout the framing operation.

12. Finish inserting brads.

13. Seal back with package sealing tape if necessary or desired. Tape can be nonporous because package is air permeable through center of the backboard.

40.4.3 Thick or Cockled Support

A. Hinging Requirements: Attach strong, pendant hinges to the object. If the object is warped, attach hinges to those portions of the upper edge which naturally come in contact with the backboard as the artwork rests on it. Weight with bean bags or cloth snakes of lead shot to accommodate the shape of the object while weighting or use layers of felt instead of blotters and glass/Plexiglas squares. If hinges must be applied to areas which are out of plane, use blocks of polyurethane foam to fill the space between the object and the work surface, and use cushions of folded Japanese tissue under weights.

B. Matting Requirements: Deep space, equal to the thickness of the support.

1. Sink Mat

- a. Cut two pieces of 4-ply board the same size; cut an overmat window in one piece (objects cannot be floated in a sink mat.) The other piece will serve as the backboard.
- b. Align the backboard, object, and window board over each other as they will be positioned in the completed mat. Hold the object in place with a light weight. Without disturbing the object, set the window board aside.
- c. Secure pendant hinges with pasted crossbars. Weight and allow to dry.
- d. Cut strips of ragboard or single or double wall acid-free corrugated cardboard to serve as fillers in the sink mat. Grain should be parallel to the grain of the window mat and backboard.
 - 1) Width for left, right, and bottom filler strips: Should butt backboard edge and come within a fraction of the object edge.
 - 2) Width for upper filler strip: Should extend from upper backboard edge to the top of the crosstabs on the hinges (This filler strip is not adhered to the backboard.). The upper filler boards neither support the weight of the object nor prevent its movement in the mat.

e. Determine the number of thicknesses of matboard or acid-free cardboard strips required to equal the thickness of the object (or if the object is warped, its highest point). Cut additional filler strips for each side.

f. Place at least two pieces of Scotch Brand Double-sided 415 Tape lengthwise on the back of each strip. Place the tape leaving a 1/4" space on all sides. Assemble the matboard strips, aligning them perfectly, to form a block. Position each block carefully against the backboard and press firmly into

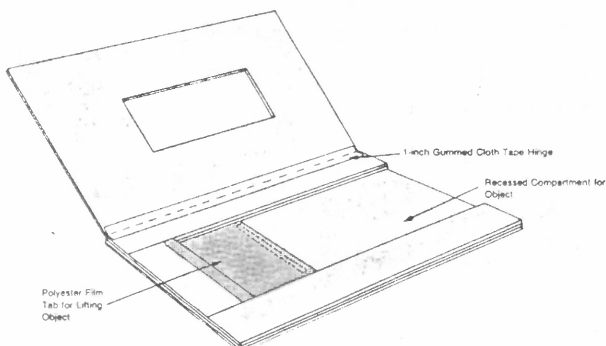

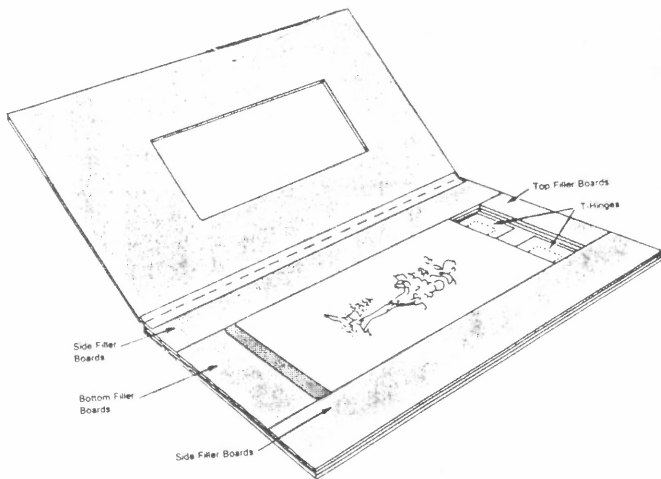

- place. Follow these steps for each side.
- g. Before placing the bottom block of filler boards in position, use the 415 tape to attach a piece of polyester film or archival paper to the backboard so that it extends out from under the object. This serves as a tab to safely lift the object out of the sink construction.
 - h. The upper filler boards neither support the weight of the object nor prevent its movement in the mat. They fit between the side filler boards, extending from the upper edge of the backboard to the top of the cross tabs on the hinges without taping.
 - i. Attach the window board to the top of the filler boards along the longer dimension of the mat (See **40.4.2.B. Matting Requirements: 5. Assembling the Mat.**)

2. Contoured Mat: For warped, stiff supports

- a. Create sink mat as described in 40.4.3.B.
- b. Lay work on flat surface and cut 1/4" wide strips of ragboard of differing lengths
- c. Stack the rag strips under edges of art to fill gaps. Remove and adhere these strips together with Jade 403 or Elvace.
- d. Adhere stacks of ragboard strips to appropriate edges of sink with Jade 403 or Elvace.
- e. Attach a lifting tab of acid-free paper or polyester film adhered with Jade 403 or Elvace to the backboard. Insert art when tab is dry.
- f. Create reciprocal contours for inside of window and face with 2-ply on sides to hide the stepped piles of ragboard. Remove art and adhere stepped strips together and then adhere to window.

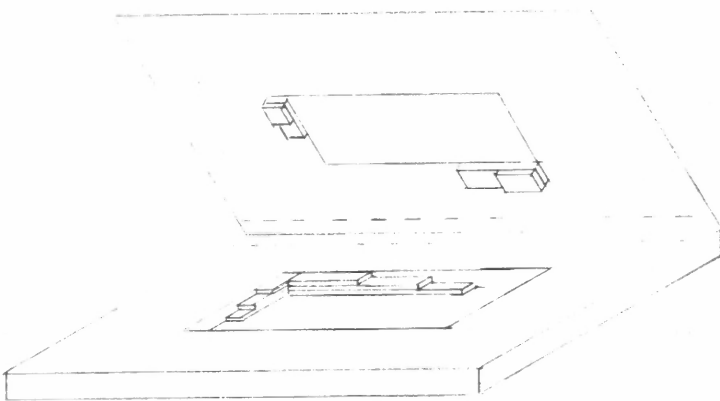

- g. To lash shut with linen tabs: Cut three slits through three sides (sides and bottom) of backboard. (To locate placement of linen tape tabs, invert the mat and use a bonefolder to rub over these slits to cause a light impression on the inside of the window mat.) Adhere 3/4" strips of linen tape to the inside of the window corresponding to the location of the slits. Attach label on back explaining how to open mat.
- h. Hold the mat face up and place the object into the sink. Slip the ends of the linen tape into the slits and pull through to the back. (Working with the mat extended over the edge of the tabletop allows one to pull the linen tabs through.) Adhere linen tabs to the back with moistened linen tape.
- i. If mat has been lashed shut, note this on the back of the mat. Also note instructions for undoing the mat.

3. Deep Windows:

a. **Stacked Bevel Pieces:** In this variation, the window is built up using stacks of beveled matboard strips

- 1) Ascertain the number of plies needed to create the depth required.
- 2) Measure the extra width and height required due to the additional plies around the window. The height of the stack equals the extra width and height required for measuring the window opening properly.
- 3) Cut the window, allowing for the extra width and height required for the additional plies.
- 4) Adhere ragboard strips with bevels cut on one side and properly align them to create one deep bevel edge. Use quick-setting Elvace to adhere the strips.
- 5) Holding a single edge blade with two hands, cut into the bevel face at a 45 degree angle. Cut into the bevel stack by approximately 1/4 inch.
- 6) When initial cut has been carefully made for the first 1/4 inch, the rest of the stack may be cut roughly with a utility knife. It is only essential that the corners of the stacked bevels fit well together. The rest of the stack is invisible, hidden under the window mat.
- 7) Adhere these sections to the back of the window opening with Elvace, carefully aligning them so that they appear to form one bevel with the window mat. Adhere acid-free cardboard scraps to fill the space around the beveled ragboard strips.
- 8) Cut a window approximately equal to that of the deep window mat out of a sheet of 2-ply. Adhere this with Elvace to the inside of the deep window mat to act as a smooth liner.

b. **Vertical Walls:** Vertical strips of 4-ply matboard line the inside of the mat equal to the thickness of the object. This variation is lightweight, makes use of available scraps and is quick, but the thickness of the window will tend to cast shadows on the object when displayed. The size of the window must be measured to accommodate the cast shadows.

- 1) Determine the depth required by standing a ruler on end next to the object laid on a flat surface.
- 2) Measure for window opening. Allow space around the object so that the shadows cast by the thick window mat will not cover the object.
- 3) Cut opening for window.

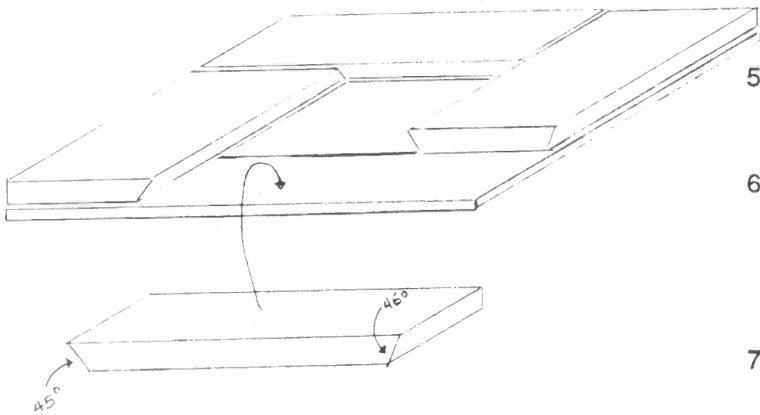

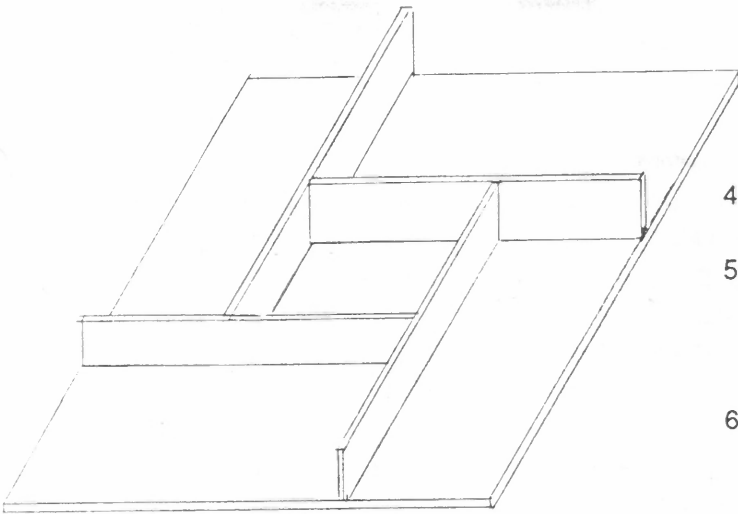

- 4) Cut strips of 4-ply to depth required. These will serve as side walls around the inside of the window.
- 5) Adhere walls to the back of the window using Jade 403 or Elvace. Start at a corner and proceed to the next corner until the window is enclosed as in the diagram.
- 6) Fill hollows in back with acid-free corrugated and line with 2-ply adhered with double sided tape or Jade 403 or Elvace.
- 7) Hinge window mat to backing as for standard mat.

c. Bevelled Walls: Lightweight acid-free window mats can be made to virtually any depth by applying a properly cut bevel strip to the back of an appropriately enlarged window mat. (The cutting device used must produce 45 degree cuts. C+H and Dexter do not work.)

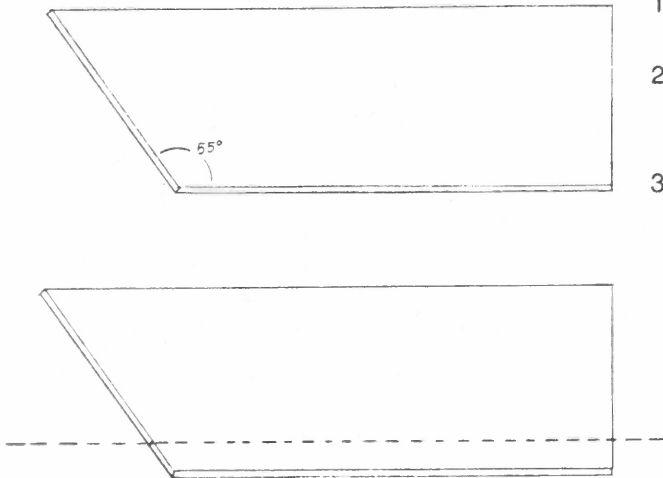

- 1) Determine the depth required and find that figure on the run/rise/depth part of the chart included.
- 2) Cut a window with the opening expanded by twice the depth/rise in both the horizontal and vertical depths of the window.
- 3) Prepare bevel strips.
 - a) Cut a section of ragboard 6"-8" wide and 20"-40" long.
 - b) Cut a bevel on one (long) side of the strip.
 - c) Make a mark 6"-8" from one end of the strip at the edge of the cut bevel.
 - d) Set the degree point of a protractor at that mark and put a mark at the 55 degree point which falls nearest the end of the strip.
 - e) Cut a bevel along the line formed by those two points.
 - f) With a carpenter's scribe carefully mark the width required by the appropriate bevel listing on the chart after adding 1/16" to account for the width of the bevel at the edge of the strip.
 - g) Carefully cut along the marked line making sure that the strip is the same width along its entire length. Repeat this until an adequate supply of bevel strips have been made.
- 4) Apply the strips to the back of the opening in the window mat
 - a) Erase any graphite
 - b) Run a bead of Elvace or Jade 403 along the back of the window and smooth with a finger or a brush.

CALCULATIONS FOR PREPARING BEVELED STRIPS

RUN/RISE	BEVEL
1/8	3/16
3/16	1/4+
1/4	3/8-
5/16	7/16
3/8	1/2++
7/16	5/8
1/2	11/16
9/16	13/16-
5/8	7/8
11/16	15/16++
3/4	1 1/16
13/16	1 1/8+
7/8	1 1/4-
15/16	1 5/16
1	1 3/8++
1 1/16	1 1/2
1 1/8	1 5/8-
1 3/16	1 11/16
1 1/4	1 3/4+
1 5/16	1 7/8+
1 3/8	1 15/16-
1 7/16	2++
1 1/2	2 1/8

± = 1/64" ±± = 1/32"

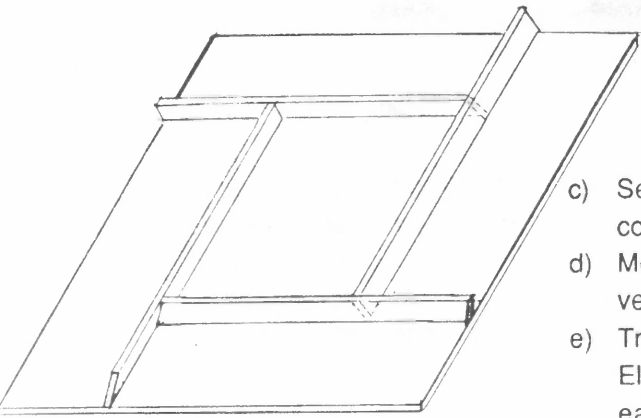

- c) Set the strip onto the glue line and its pointed end touching the corner of the window. Allow the strip to extend past the far corner.
 - d) Mount the other three strips to produce a "pinwheel" layout (as for vertical wall type.)
 - e) Trim the excess at the corners with a scalpel or a razor and paint Elvace/Jade 403 on the butting portion of the strips and adhere each to its neighbor.
 - f) Reinforce the back of each corner with linen tape.
- 5) Fill the hollow portion around the constructed bevel with glued acid-free corrugated board. Line the back with two-ply and add vertical side walls to the outside edge if needed.

C. Glazing Requirements:

D. Framing Requirements:

E. Assembling Mat, Glazing and Frame:

40.4.4 Insecure Media (Friable or Flaking):

A. Hinging Requirements: Do not hinge behind image.

1. **Pass through hinge:** The hinge paper is passed through a beveled cut in the backing and attached like a pendant hinge above the object or behind the object on the reverse of the backboard. Because the hinge can be attached to the backing using tape (linen tape is recommended), pressure is used on the object only when applying the hinge to it. This may be desirable for an object with friable media.

a) **Attachment to object:** In some instances, where weighting of hinges is not possible, a suction table or disc can be used to assure contact while drying. (EKS)

- 1) Support the object face up on a blotter with the edge to be hinged overhanging the blotter and the edge of the work surface.
- 2) Apply the hinge as dryly as possible under the edge of the object. Press the hinge lightly up against the object with silicone release (or other) paper covering the hinge.
- 3) Blot the moisture from the hinge by pressing several times as described above with blotters.
- 4) Shift position so that the whole object is now supported on the blotter and work surface.
- 5) Place silicone release (or other) paper under and over hinges. Weight with cushioned weight.

b) **Attachment to backing:**

- 1) Position the object correctly in the completed mat. Weight lightly in place.
- 2) With a scalpel, draw horizontal lines along the top edge of the object, marking the position and width of the hinges.
- 3) Remove the object.
- 4) Make beveled cuts in the backboard with the beveled angle either beginning at the top edge of the object and proceeding upward (with

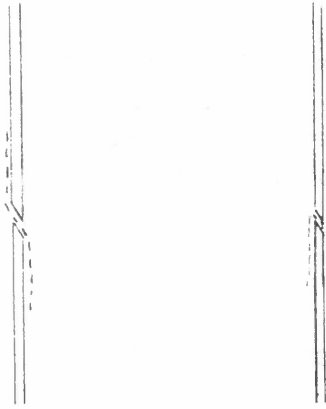

the bevel in this direction, the hinge will rest supported on the bevel without encountering a sharp matboard edge which may weaken the hinge tissue) or beginning at the top of the object and proceeding downward (with the bevel in this direction, the hinge rests against the sharp edge. In the event of rough handling, the hinge, rather than the object, will tear).

- 5) Reposition the object.
- 6) Place the hinge tissue inside a piece of folded silicone release paper small enough to get through the beveled cut.
- 7) Pass the silicone release paper through the cut, taking the Japanese tissue with it.
- 8) Attach hinges above the object (as a pendant hinge) or behind the object using a linen tape crossbar. The linen tape may be slit to remove the object with hinges undamaged and reusable.

c) Attachment to backing -Alternate Method:

In some cases, it may be difficult or potentially dangerous to the object to pass through hinges from an already hinged work. The prepared hinges may be passed through the board and adhered to the backing, the object then positioned, and the hinges adhered to the object from the front.

(DT,FZ)

B. Matting Requirements: Extra separation using deep windows or spacers, rigid support to avoid flaking where media is brittle.

1. **Standard Mat with Cover:** The Library of Congress recommends this mat for objects with friable media where a cover sheet may not be used for protection.
 - a. Prepare three pieces of 4-ply matboard the same size. Prepare a standard single window mat.
 - b. Cut a strip of white, starch-filled reinforcing cloth the length of the long edge of the matboard and 2" wider than the thickness of the three boards. The cloth grain is parallel to its length.
 - c. Apply Jade 403 to the back of the cloth strip. (Use Jade 403 the consistency of very heavy cream.)
 - d. Lay the cloth on a clean work surface. Position the standard mat on the cloth covering 1" of the width.
 - e. Align the cover over the standard mat. Weight in place.
 - f. Using a bonefolder, turn the cloth up over the edge of the protective cover without gaps or puckers. Use a waste sheet to smooth the cloth and ensure contact on front and back of mat.
 - g. Open the mat. Pull the cloth away from the edges of all three pieces of matboard. (The cloth should act as a hinge.)
 - h. Close and air-dry. (LC)

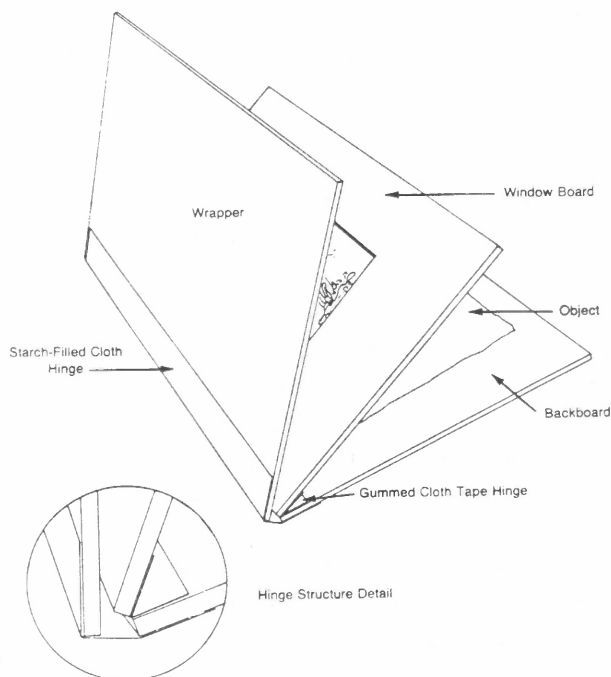

C. Glazing Requirements: Glazing free from static charge. It is not recommended to double glaze, adding a sheet of UV filtering acrylic over glass. If this is done, the glass cannot be taped for travel and if broken, potential for damage to object is greater as the glass cannot fall away from the object. Also, when glass and acrylic sheeting are sandwiched together, the two form a moire effect, due to their differing diffraction of light.

D. Framing Requirements:

1. For mounted pastels or charcoals or other friable media which extend directly to all edges, create a flexible support at the inside of the spacer and frame to protect friable edges.
 - a. Cut a strip of acid-free paper at least two inches wider than the depth of the frame. The strips should be as long as the four sides of the frame.
 - b. Adhere the smooth acid-free paper to the front of the spacer. Adhere spacer and paper to the frame using Elvace.
 - c. Pull the paper so that it creates a diagonal across the angle of the frame (see diagram below) and adhere with Elvace on the inside and back of the frame.
 - d. The edge of the object will rest on the diagonal of paper which you have created, allowing a softer, more flexible support for edges than the square interface of the rabbet and the sides of the frame or the spacer and the sides of the frame.

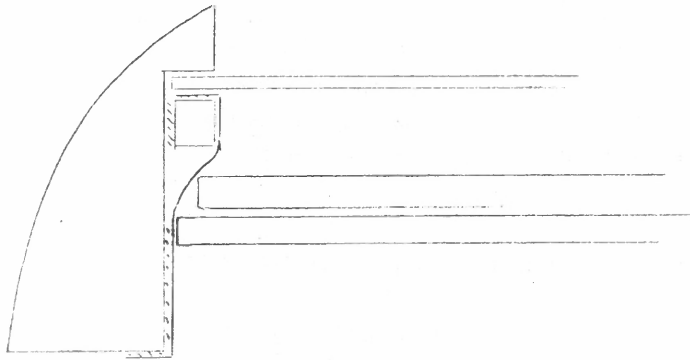

E. Assembling Mat, Glazing, and Frame:

40.4.5 Oversize

- A. Hinging Requirements:** Additional top hinges (or entire top) or side and bottom hinges may be added to object.
1. **Velcro:** Used for hinging large objects. Attach female to Japanese tissue patches (adhered with paste) on the verso of the object. The velcro may then be adhered with Elvace. (MBC)
 2. **Serrated Hinge:** The side of the hinge to be attached to the artwork is cut in a zigzag fashion. Only the points of the hinge are attached to the artwork. The points can be teased out if Japanese paper is used. With this non-continuous hinge arrangement the hinge can be made quite long and yet only minimally attached to the artwork. This has been used successfully on very large, modern works where traditional hinges would cause distortion of the paper surface over time. (LK)
 3. **Strip Lining:** Oversize objects have been successfully attached to rigid supports using the strip lining technique. Conservators have used this technique to comply with artist's wishes to display works on paper without

typical matting or to resemble painting presentations. Water-soluble wheat or rice starch pastes may be used for this technique, however, their use presents some problems. If Japanese tissue is used, it can cockle overall causing the object to buckle. This problem may be alleviated by using dry lining techniques for applying the paste to the tissue segments and by creasing the Japanese tissue strips before pasting the edge. Apply Japanese tissue with grain perpendicular to the edge of the object. Fold and crease the tissue perpendicular to the object edge. This "pre-creasing" helps the dry portion of the tissue to accommodate the moist paste application along one side without cockling. Adhere several segments of Japanese tissue (apply approximately one quarter to one half inch including the feathered edge to the object) along each side and allow to dry thoroughly. Position the object on a rigid support, such as Tycore or a ragboard covered stretcher, and wrap the segments attaching at the back of the panel or stretcher using linen tape or paste with some Elvace added. Attach segments as for stretching a canvas. Starting at center, attach the center segment on one side then the opposite side. Proceed, continuing to attach corresponding segments on opposite sides. When the nature of the object support has not allowed the use of water-soluble starch pastes, heat setting synthetic dispersions have been successfully used. Rhoplex and Lascaux dispersions have been found to be adequately reversible. Experiments are also being done with Beva films. The adhesive can be applied to the strip lining material, allowed to dry and then positioned on the object and heat set in place. Jade 403 is not considered an acceptable material for strip lining because it is not easily reversible. The selection of the paper or fabric for the strips depends on the weight of the object. The most important factor is to create a fine edge which will not make a crease or bump in the object. The soft edge of water torn Japanese tissue should be applied to match the grain of the object. When stronger materials are required, canvas strips have been used with the edges unravelled to soften the edge. Polyester fabric and spun-bonded polyester web have also been used successfully for strip lining in conjunction with heat sealable synthetic adhesives. In general, wheat and rice starch paste have not been found to adhere adequately to canvas, polyester or polyester web. Strips should be applied so that they do not overlap, causing undesirable double thickness at corners. Tycore panels and covered stretchers have been used most often for backing strip lined objects. Stretchers may be covered with ragboard or acid-free corrugated board. However, it has also been useful to cover a stretcher with canvas or sheets of Japanese tissue in order to provide nap which will additionally support and hold the object in place all over its surface (AO, BF, PV).

- B. Matting Requirements:** Openings larger than 40" can be cut on a standard 40" cutter by marking the face side of the board 1/16" wider than the desired opening. The board can be inserted from the left side of the cutter (instead of the right as is usually done) and cut on the marks without crossing over. This only works if the

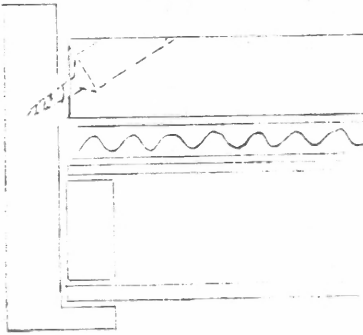

sides are not more than 5"-6" wide. Rigid yet lightweight matting materials to support large size.

1. **Paper Honeycomb panels** (for sizes up to 4 x 8', honeycomb panels weigh approximately 16 lbs.)
2. **Aluminum honeycomb panels**
3. **Rag with acid free corrugated underneath**
4. **Stretcher with acid-free corrugated and rag on top:** This method is advantageous because it allows for building custom sizes. The stretcher can be attached to the frame using countersunk screws as diagrammed.

C. Glazing Requirements: Plexiglas, which is lighter in weight than glass. Use 1/4 inch Plexiglas for very large objects.

D. Framing Requirements: Extra depth to accommodate bowing and warping of backing or Plexiglas and cockling of object. Plexiglas may be adhered to rabbet to prevent bowing and popping out.

E. Assembling Mat, Glazing, and Frame:

1. One solution for oversized Plexiglas

When framing an object, 10' x 4', the following procedure was devised to support the Plexiglas along the top edge of the frame. This method prevents the Plexiglas from bowing.

- a. The molding should be routed out along the top edge to create an extra wide rabbet.
- b. Cut the Plexiglas sheet to fit the frame with the extended rabbet.
- c. Drill holes or slots through the Plexiglas along the top edge.
- d. Screw the Plexiglas to the top edge of the rabbet loosely. Rubber grommets may be added to cushion the attachment. The screws should not be tight.
- e. The Plexiglas is allowed to hang. (FS)

40.4.6 Double Sided Objects

A. Hinging Requirements: Balancing the need to view-exhibit both sides with the need to provide adequate support for the paper and protection for the media.

1. **Japanese Tissue Window:** This method gives adequate support of objects with images to the edges of both the recto and verso. No hinges cover the media. Water-torn fibers obstruct the image as little as possible while supporting the object on all sides.

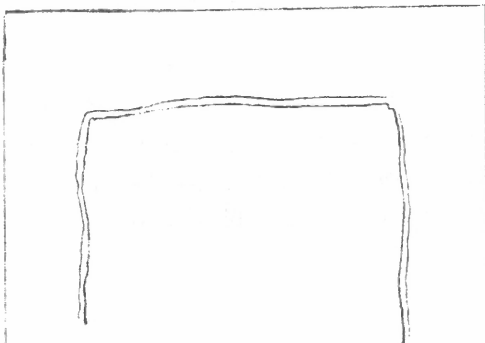

- a. Place the object on top of a 2-ply board. Trace 1/16"-1/8" around the perimeter of the object with a bonefolder. Remove the object.
- b. Cut out the tracing.
- c. Prepare strips of Japanese tissue of suitable weight and preferably of a tone which will blend well with the tone of the object. The strips should be

approximately 1 1/2" - 2" wide. Length depends on the size of the object. Grain should be perpendicular to the length. Water tear one edge on each strip.

- d. Adhere the strip of Japanese tissue to the 2-ply with wheat starch paste so that a fringe of water-torn fibers extends into the cutout. The object will be hinged with these fibers. Avoid cockling the 2-ply by weighting overnight.
- e. Choose the side to which the fibers will be adhered. With that side face up, set the 2-ply window over the object. Note in pencil on the 2-ply areas where fibers would come in contact with the design. Remove fibers or simply do not paste.
- f. Paste and the fibers in 3-4" sections at a time around the perimeter. Blot as required.
- g. Attach the the pasted segments to the object. Apply release paper, blotters, acrylic squares and weight over the pasted fibers.
- h. Hinge the 2-ply to one window of a double-window mat with appropriate covers. Alternatively, hinge the 2-ply window into a standard mat and place release paper under the object, thus avoiding the dangerous double window construction.

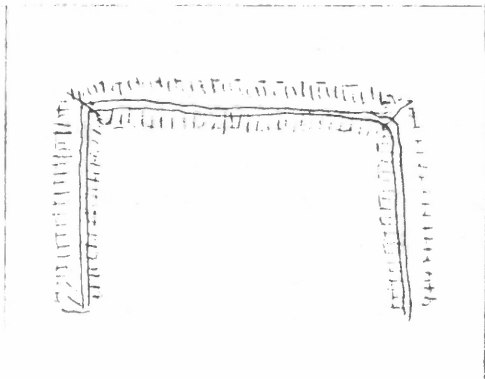

B. Matting Requirements: When there are window openings on both the front and back boards, the artwork is vulnerable to puncture and must be protected. Therefore, the Library of Congress has recommended that this mat structure should either be supplemented with protective covers or used in conjunction with a frame or a Plexiglas enclosure. Sandwiching art between two pieces of acrylic sheeting without mat is not recommended.

1. Double Sided Mat

- a. Cut two 4-ply boards to the same size. Cut two windows that reveal the desired images or information. Save the cutouts. At most, one side of the object can be floated.
- b. Attach the two boards along one long side (See 40.4.2.B. Matting Requirements: 5. Assembling the Mat.)
- c. To position the artwork so that it is correctly aligned in both the front and back window openings, lay the closed mat on the work surface with the cutout replaced in the back window opening. Position the artwork in the front window as desired. Then replace the cutout in the front window. Carefully turn the

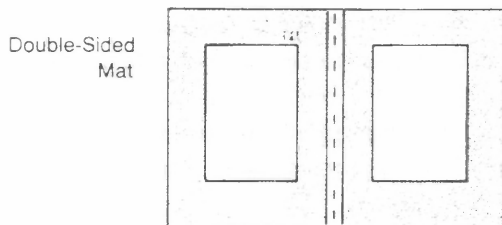
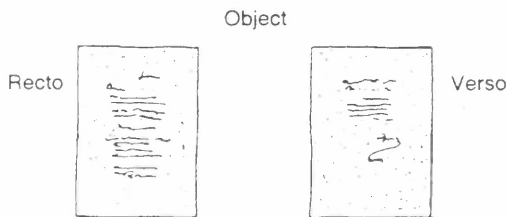

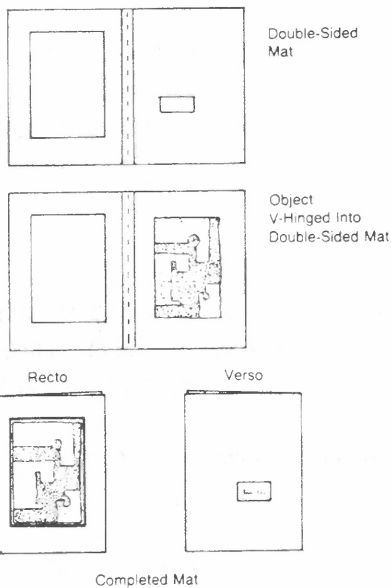
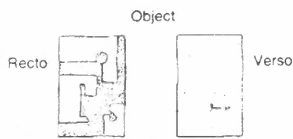
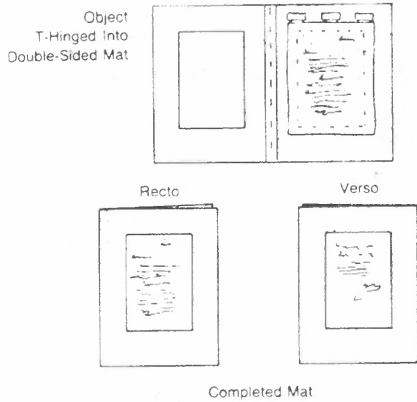

- d. With the back cutout in place below the artwork, place the mat, face up, on the work surface. Weight the artwork in the center.
- e. Open the mat without moving the back window board or the weighted artwork.
- f. Secure the artwork in the mat. Use pendant hinges if the object is overmatted. If one window is larger than the artwork and the other is considerably smaller, float the object with V-hinges attached to the board that has the smaller opening.

2. Hinging Double-Sided Objects To Two-ply Windows.

For works which may be unframed for examination or storage, hinging the work to one of the two four-ply windows could be hazardous. Hinging the object to a two-ply window in between the two four-ply windows (onto which the art object is then hinged) allows the mat to be safely opened from either side without placing stress on the hinged work. (MBC)

- a. Cut a window in the two-ply to reveal the desired information on the verso.
- b. Using two strips of 1" wide linen tape at the spine, hinge the two-ply window to the front window and to the back window so that all three mats are attached at the spine and open as separate leaves of a book. Apply linen tape and dry as usual.
- c. Proceed with hinging object into mat. Note cautions on mats for careful opening by scholars, curators. (DT, FZ)

- C. Glazing Requirements:
- D. Framing Requirements:
- E. Assembling Mat, Glazing and Frame:

40.4.7 Non-paste Alternatives

- A. Hinging Requirements: One of a kind or specially made paper/synthetic adhesive hinge systems may be indicated for temporary use on supports to which cooked starch paste will not adhere or where, because of the nature of the support, moisture cannot be used for hinge application or later hinge removal (where the use of water introduces severe cockling) or for display of transparent objects. Caution:

Synthetic adhesives are not recommended for permanent hinging and should only be used if they can be safely removed from the paper, i.e. solvents used for removal are safe to apply to the object.

- B. Matting Requirements:**
- C. Glazing Requirements:**
- D. Framing Requirements:**
- E. Assembling Mat, Glazing and Frame:**

40.4.8 Brittle Supports

A. Hinging Requirements:

Brittle supports may be encapsulated with a buffered sheet for long-term housing or temporary display. (See **40.5.2. Matting Without Hinging.**)

Brittle supports may be attached to backings using a type of false margin of very soft, water torn Japanese tissue along the top edge. This serves to distribute the attachment along the entire edge rather than isolated hinge spots on the brittle and fragile paper. (MBC)

- B. Matting Requirements:**
- C. Glazing Requirements:**
- D. Framing Requirements:**
- E. Assembling Mat, Glazing and Frame:**

40.4.9 Supports with Uneven Upper Edges; Irregular Edges:

A. Hinging Requirements:

1. **Paper Inlay:** This technique is not recommended for routine use. It is useful for objects with irregular edges and objects with recto/verso images which must be available for study and handling. The inlay paper affords handling without directly touching the object. The inlay paper must be physically and aesthetically compatible. It is not recommended to inlay paper objects into heavier weight card or bristol.

- a. Choose paper of the same weight. Align laid lines and grain with those of the object.
- b. Place the object face up on the inlay paper. Using a blunt edge, incise around the edge of the object.
- c. Cut with a scalpel blade or single edge razor around the inside of the incised lines. Allow approximately 1/8" space between the incised lines and your inside cut edge. Remove and reserve the inside of the inlay sheet.
- d. Bevel the edge of the inlay sheet, aiming for a 1/16" beveled edge. Check bevel in transmitted light.
- e. Invert the object and place the cutout inside of the inlay sheet on top. Brush a light application of paste around the edges of the object. Quickly invert the object and match it up to the inlay sheet.
- f. Quickly place the object under weight.

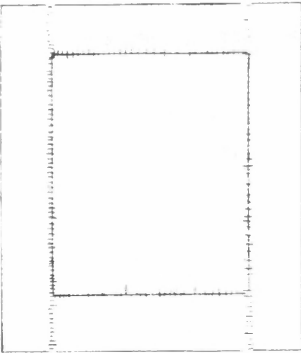

2. **False Margin:** A false margin protects the edges of brittle objects, secures and fills irregular edges and offers a secure surface for hinging the object. Choose a Japanese tissue of suitable weight and color. It is most important to match the grain of the tissue to the grain of the object paper. Prepare strips of Japanese tissue with feathered edges. Do not overlap the tissue when applying to the object (see diagram). Adhere the feathered edges of the Japanese tissue strips using wheat starch paste. Weight to dry.

- B. **Matting Requirements:**
- C. **Glazing Requirements:**
- D. **Framing Requirements:**
- E. **Assembling Mat, Glazing and Frame:**

40.4.10 Thin Papers

- A. **Hinging Requirements:** Use a water-torn Japanese tissue hinge and attach only the fibers to the object. Use a hinge prepared with a serrated edge and attach only the points of the serrated edge to the paper.
- B. **Matting Requirements:** Hinging to a Japanese tissue insert can provide tooth which prevents thin tissue supports from lifting when a mat is opened.
- C. **Glazing Requirements:**
- D. **Framing Requirements:**
- E. **Assembling Mat, Glazing and Frame:**

40.4.11 Heavy Objects

- A. **Hinging Requirements:** Permalife paper corners for stiff boards (see 40.5.2.E Photo-corners.) May need "internal" hinges attached to the back of the object.
- B. **Matting Requirements:**
Lashed sink mat (see 40.4.3.2.7).
- C. **Glazing Requirements:**
- D. **Framing Requirements:**
- E. **Assembling Mat, Glazing and Frame:**

40.4.12 Parchment

- A. **Hinging Requirements:**
A string mat helps to maintain planarity. Because the strings are attached at small intervals around it's perimeter, and attached to the back mat under slight tension, the strings can adjust to changes in temperature and humidity.
 1. Cut 100% unbleached linen strings into pieces 2"-8" in length. (The larger the piece, the longer the string.) Unwind both ends of the strings.
 2. Attach one end of the unwound string to the reverse edges of the parchment at 1" intervals with wheat starch paste. Also place strings diagonally at corners. (Make sure that room in which hinging is done is adequately humidified and keep parchment under glass while attaching strings.)
 3. Attach other end of the strings to the backing with Jade 403 or similar adhesive.

B. Matting Requirements:

1. Often 8-ply or step mat is required. Addition of matboard lined Plexiglas spacers may also be necessary due to distortions (see glazing).
2. Alternatively, parchment can be encapsulated prior to matting when kept in a controlled environment. Encapsulate parchment leaving generous margins outside the weld or tape seam. Attach the margins of the encapsulated work to the backing using 3M 415 double-sided tape. The object can be floated or overmatted. Encapsulated parchment can also be matted with a double sided window mat.

C. Glazing Requirements: UF 3 Plexiglas. Plexiglas spacers may be required, attached to the glazing to create additional space between work and glazing. (EKS)

D. Framing Requirements:

E. Assembling Mat, Glazing and Frame:

40.4.13 Photographs

A. Hinging Requirements:

1. If at all possible photographs should be photo-cornered into their window mats. (This is usually only possible if the photograph is mounted and or printed with a large margin.) Light Impressions has just started to offer Cut to Size Paper Corners made from their acid-free unbuffered paper. These corners were designed by the Preservation Staff at the National Archives. Corners may be attached to the backmats with linen tape. Polyester corners should not be used as they may scratch or emboss photographic binder layers. Note that unmounted albumen photographs cannot be safely photocornered as they will simply sag.
2. If hinging is necessary then it is very important that they be applied as dry as possible. Japanese tissue should be light-medium weight. Note that many of the photographic processes such as salted paper, platinum and cyanotype can be treated as works of art on paper as binder layers are not present.
3. There has been some investigation into the use of heat sensitive acrylics for hinging moisture sensitive photographic materials. Jerry Cohn and Debora Mayer both investigated the use of AYAT in Toluene which may be coated onto a Japanese tissue of choice and applied through solvent activation or heat.
4. The Japanese tissue perimeter mount works very well for matting unmounted albumen photographs.
5. The Image Permanence Institute has conducted some preliminary tests on the effects of methyl cellulose on photographic materials. These materials appear to be safe.

B. Matting Requirements:

1. The use of an acid-free, lignin-free, unbuffered matboard is recommended with all photographic materials. If at all possible the selected matboard should be tested by the Photographic Activity Test to determine its possible longterm

harmful effects on photographic materials. Unbuffered materials must be used for cyanotype and dye transfer images.

2. Sink mats are recommended for mounted photographic materials. (See 40.4.3. Thick or cockled supports.)
3. A number of interleaving materials are currently being used with photographic materials. Some conservators recommend polyester film because it is transparent and therefore decreases the possibility of handling damage. Maria Holden (New York State Archives) has been examining a variety of possible interleaving materials for their abrasiveness. She should be contacted for her findings to date - for the most part glassine and buffered tissue have both yielded poor results.

C. Glazing Requirements:

1. Generally ultraviolet filtered Plexiglas is recommended for use with photographs unless they exhibit a deteriorated (cracked/crazed and/or flaking binder layer or the presence of friable chalk, pastel, etc.

D. Framing Requirements:

Sealed packages may be recommended for photographs, although research has not been carried out in this area. (DHN)

E. Assembling Mat, Glazing and Frame:

40.4.14. Contemporary Art

A. Hinging

1. Very large objects require hinges on all four sides. This prevents some static pull from Plexiglas in center.
2. For travel, some pieces are hinged and framed directly against Plexiglas with no spacer. Spacers in large frames do not mitigate buckling and movement of artwork. The uneven pressure of Plexiglas with a spacer can be more damaging than the overall, even pressure of the Plexiglas.

B. Reversible, Non-Hinging Techniques

1. Some oversized works (i.e. posters, prints) are held in frame with pressure only, no hinges and no spacer, This is only done for temporary non-travelling exhibits.
2. When no frame is desired, small to medium sized objects have been hinged to 4-ply ragboard (without mat) with a Plexiglas sheet over the print, and held to wall with "L" clips. This has been done for temporary exhibits. Good humidity control is essential.
3. Larger objects can be hinged to ragboard on all four sides, ragboard placed on heavy backboard, 4-ply window mat as spacer and large sheet of Plexiglas overall. Plexiglas is screwed directly into the wall, through the mat and backboard (not through the art.)
4. Velcro strips or tabs are adhered with Jade 403 or Elvace to the gallery wall.

Japanese paper hinges are pasted to the verso of the object. Corresponding pieces of velcro are adhered to the hinges on the verso of the object. Velcro is adhered with Jade 403 or Elvace to the Japanese tissue. This may be done at the top or at both the top and bottom of the object. This procedure is done when the object is too large to frame, when artists do not want glazing or when framing is impossible. The object is easily adjusted by moving velcro if necessary.

5. At an artist's request, some works are held directly against the wall or against a ragboard or Mylar interlayer which has been stapled to the wall, with push pins or tiny nails through the object. Sometimes, holes are reinforced on the verso with Japanese tissue and paste. Generally pre-existing holes are used or the artist's opinion is required. When objects need support at the bottom edge and no holes exist, the bottom edge is supported with tabs of paper which are adhered to the wall and folded up over the bottom edge of the object, and then inpainted to match the art. Sometimes, if the object is extremely heavy, larger paper tabs are placed over the bottom of the object, half on the wall, half on the object, each half inpainted to match (wall/object). A small nail is placed below the object to hold the paper tab and art in place.
6. Free-hanging works of art, i.e. Mylar or silk banners: two pieces of half-round wooden dowel wider than the artwork are clamped around the top edge of the artwork (a false edge of Japanese tissue or linen may be added) and the pieces are screwed together. The dowel is hung from the ceiling with nylon fishing thread. This allows the piece to be seen on both sides, good for transparent works, and is most often done at artist's request. Sometimes an acrylic sheet is hung several inches in front of the artwork, also on nylon thread, fastened to ceiling and floor to protect the free-hanging piece.
- 7 For temporary exhibitions when invisible hinges are needed on Mylar prints or some architectural tracing papers, small pieces of 3M 415 double-sided tape are used to hold artwork to ragboard backing. Tape can be easily peeled off and residue removed with a crepline eraser.

C. Non-Reversible Techniques

Some objects must be pasted directly to the gallery wall at the instruction of the artist. Sometimes a Japanese paper interlayer is used, but often wheat starch paste and/or Jade 403 are used directly on the wall. The artwork cannot be removed without destroying it, i.e. Billboards, graffiti art. (AK, KB, RF)

40.5 Special Considerations

40.5.1 Other attachment options

A. Chevron Hinge: This hinge is good for very heavy water-color paper. If the Japanese tissue is fairly pale, this can be used for float mats, especially if the space between the window and the object is narrow.

1. Choose Japanese tissue and cut a rectangle in a size appropriate to the size of the object with the grain

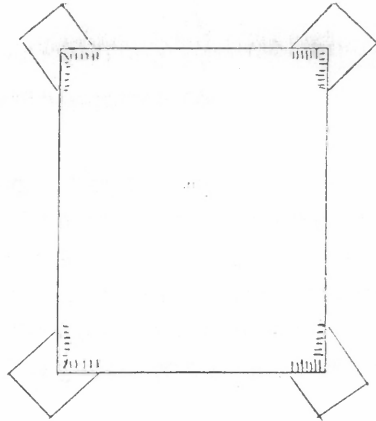

2. With the grain running vertically, cut and feather the edge as diagrammed.
3. Position the object in the mat. Weight in a non-design area if possible.
4. Paste the feathered edge of the hinge. Adhere to the verso of the object. Weight and allow to dry.
5. Position the object in the mat. Weight in a non-design area if possible. Paste out hinges, allowing an unpasted space of about 1/4" from the object's edge. Smooth hinge onto backing. Weight and allow to dry. (Elvace can also be used.)

40.5.2 Matting without hinging

- A. Polyester Sling:** The polyester film sling developed at the Library of Congress provides a method of securing an art work into a mat without hinges. It consists of a polyester film support that covers, but is not attached to, the back of the object. This support is attached to the window board of the mat with 3M Scotch Brand double-sided tape No. 415 so that the object is held in place against the window opening. The sling is usually employed as a temporary housing for objects which are not stored in mats, but require matting for exhibition. The polyester sling eliminates the need for mounting, holds the object securely without hinges, and is fully reversible.

Three structural features of the polyester sling could lead to damage of the art work if they are not considered. First, it is possible that large, heavy objects might move down in the sling and come in contact with the double-sided tape on the lower edge when the mat hangs in a vertical position. Such shifting could also occur when a framed art work is packed and shipped for exhibition, especially if it is jolted or dropped. If the object does come in contact with the tape, some adhesive transfer could occur. Such transfer can be avoided by slipping welded Mylar spacers around the edges of the object. If the object slips, the spacer and not the object will come in contact with the adhesive. Second, once the art work is secured in the sling, a slip sheet cannot be inserted under the window board to protect its surface. Third, when the art work is suspended in the window opening by the polyester sling, it is not protected from puncture when the window board is lifted up from the backboard.

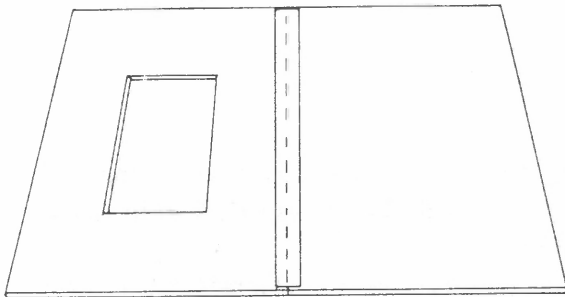

The design of the polyester sling requires that the art

work be sandwiched between the window board and the sheet of polyester film. Therefore, it is not possible to float an art work in the window opening. Since there must be sufficient space in the mat to lay the tape down around the art work, the mat's dimensions must exceed those of the art work by at least 1 1/2". The size and weight of the art work to be matted govern the thickness of the polyester film selected for the construction of a sling. Thickness of three and four mils are usually chosen for all but the largest and smallest items. If the art work is large, heavy, or thick, the 1/2 inch wide double-sided tape will make a stronger construction than the 1/4" wide tape.

One method for constructing a polyester sling follows:

1. Cut a piece of polyester film at least one inch larger in every dimension than the object.
2. Prepare two pieces of matboard the same size. They must be at least 1 1/2" larger in every dimension than the art work.
3. Cut a window opening in one board so that the edges of the window overmat the object by at least 1/8".
4. Hinge the window board and backboard together as in the standard mat.
5. When the mat hinge dries, open the mat and place the object on the backboard with the polyester film beneath it. Position the polyester film so that its edges are parallel to the edges of the backboard, then close the mat and position the object in the window opening as it will appear in the finished mat.
6. Place a piece of blotter and a weight on a flat area of the art object, being careful not to press out any raised or delicate surface area.
7. Open the mat to expose the entire front of the object to view. Attach spacers.
8. Place four lengths of 3M Scotch Brand double-sided tape No. 415, 1/4" or 1/2" wide, on the polyester film around the object, no more than 1/8" from its edges. Care must be taken to ensure that the tape never touches the object. The tape should extend beyond each corner of the object by 1/4" or 1/2", depending on which width of the tape is used.

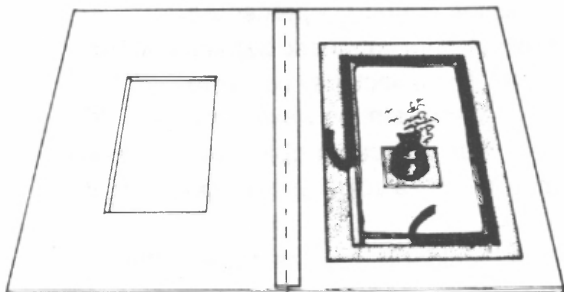
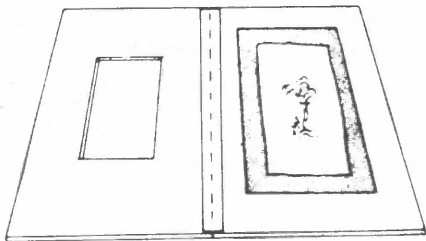

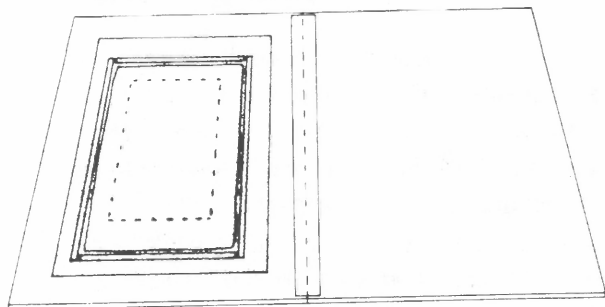

9. Remove the blotter and weight, then carefully remove the brown release paper from the tape. Close the window board and press gently to attach it to the tape.
10. Open the window board once more and rub down the tape with a soft, antistatic cloth to ensure a solid bond between the tape, board and polyester film.

One method for dismantling a polyester sling:

1. Place the mat on the work surface and open it so that the image is face down and the polyester film is face up. Without covering the polyester film, place weights on the backboard and window board.
2. Cut the polyester film between the tape and the art work on three edges with a sharp scalpel or knife and straight edge. Take care not to cut the art object.
3. Peel back the freed edges of the film and remove the object. Check all the edges of the object for any adhesive tape residue. It is usually possible to remove such residue by carefully rubbing a crepe square (also known as an artist's pickup) over the sticky areas.

- B. Japanese Tissue perimeter mount:** An adaptation of photo corners using Japanese paper strips which overlap the entire length of all four edges of the object. The strips are adhered directly to the back mat just outside the edge of the object using 1/4" Scotch Brand double-sided tape number 415. With the object appropriately situated on the backmat, the tape may be applied to the backmat approximately 1/8" outside the object's edge. A Japanese tissue strip is then applied to the tape, overlapping the object's edge. The strips should be wide enough to provide an overlap of 1/8"-1/2" (or more; depending on the size and weight of the object and the mat overlap) and to accommodate attachment to the backmat, i.e. allowing approximately 1/8" space outside the object edge with a 1/4" allowance for the tape. Once applied, the paper strips must be thoroughly burnished over the tape edge, carefully avoiding the adjacent object edge to ensure secure attachment of the strip and to prevent the object's edge from coming into contact with the tape edge. The object should be covered with a protective sheet and gently weighted as possible during the procedure. Mylar or archival western paper may be substituted for Japanese paper if a stiffer material is required for a large or heavy object. The object may be perimeter-mounted to a 2-ply insert to facilitate proper placement in the window mat. (DT,FZ)
- C. Polyester encapsulation:** For display of brittle objects or objects which would not otherwise be hinged, temporary encapsulation is a solution. The polyester film is undetectable under glazing.

Encapsulate objects using a heat or ultrasonic welder to seal the edges of the polyester film. Remove encapsulation after display.

Encapsulation should be evaluated in light of the condition of the object if long-term enclosure is considered. Recent accelerated aging tests at the Library of Congress have shown an accelerated decline of the physical properties of

encapsulated neutral and acidic papers compared with unencapsulated controls. These papers benefited from the inclusion of alkaline paper in the encapsulated package. (The neutral paper aged at the same rate as the unencapsulated control while the acidic paper benefited by encapsulation with alkaline paper.) These findings support the initial recommendation made by the Library of Congress in its 1980 pamphlet, **Polyester Film Encapsulation**, that objects be deacidified before encapsulation.

Many art objects on paper cannot undergo aqueous or non-aqueous deacidification treatments. Long-term encapsulation still offers significant protection against damage due to handling or unprotected storage. The structural support and protection afforded by encapsulating untreated (not deacidified) objects may still outweigh the danger of the accelerated decline in physical properties in terms of the actual preservation of the object.

D. Paper Cradle: For objects on brittle boards with fragile edges, the paper cradle protects friable edges. Objects can be supported without hinging.

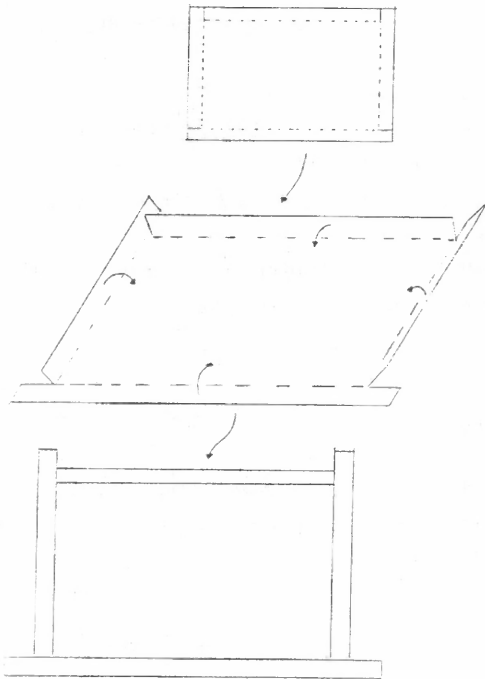

1. Create a sink mat as described in 40.4.3.B.
However, allow 3/4" to 1" space around the object before building up the sink. (Object does not fit snugly into the sink.) Create an overmatting window.
2. Cut a sheet of acid-free paper slightly larger than the dimensions of the object. (Size will be determined by the thickness of the board and the width that is covered by the overmatting window. In other words, cut the paper so that when the edges are folded over the edges of the object the paper will be hidden by the overmatting window.)
3. Make cuts in the paper up to the outside edge of the object as diagrammed below.
4. Fold edges to the front of the object by folding the top edge down first, followed by the side edges and finally the bottom edges. This will create two vertical tabs at the top corners where the vertical cuts were made in the paper and two horizontal tabs at the bottom corners where the horizontal cuts were made in the paper cradle.
5. Remove object from paper cradle. Affix paper cradle to sink mat using double-sided tape.
6. Place object into sink, fold cradle around to front and fix tabs to backboard with linen tape. Close window.

E. Photo Corners: An excellent method for attaching objects to backings for temporary exhibits without hinging (for example, for objects which are not ordinarily hinged for storage.) Photo corners are also good for permanent use on stiff objects which tend to support themselves. Photo corners may be purchased or homemade using acid-free paper, polyethylene film, polyester film or Japanese tissue. For display, paper photo corners may be used when the object is

overmatted so that they will not show. Polyethylene or Mylar corners may be less visible on floated objects. The sharp edges of Mylar may damage some media (such as photographic emulsion surfaces). A tone of Japanese tissue may be chosen that is not easily detectable. Attach to backing with linen tape (for heavy objects) or acid-free paper tape. For display, attach to backing using Elvace sparingly.

1. Method 1



- a. Cut a strip approximately twice as long as it is wide.
- b. Hold the strip horizontally; fold the top corners in at a 45 degree angle to form a triangle.
- c. Apply to the object with the flaps at the back.
- d. Attach by taping across the triangle with linen or archival paper tape.

2. Method 2

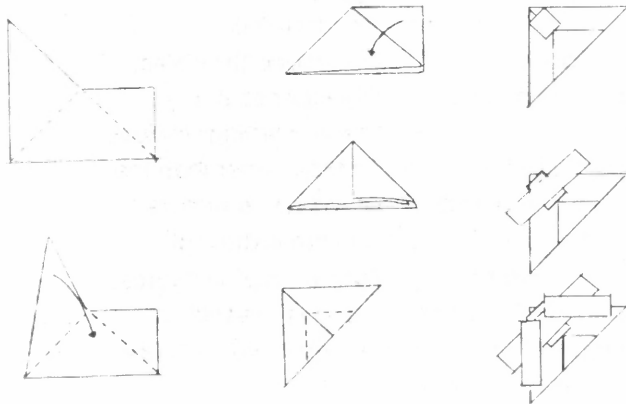
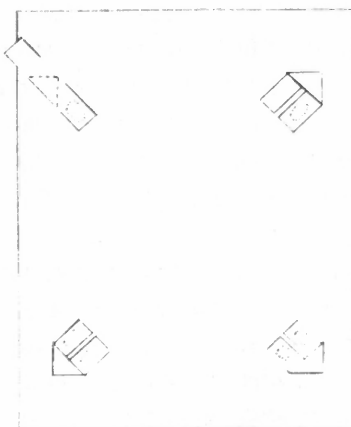

Photo corners developed by the National Archives are an improvement over the simpler construction which has been observed to slip.

- a. Start with a square of smooth, acid-free paper. Fold once in a triangle.
- b. Fold this triangle a second time.
- c. Open the sheet back up and cut along the folds to create the shape diagrammed.
- d. Refold the paper so that a triangle is created with a half triangle flap on top.
- e. The inside of the triangle may be cut out if the photo corner would show through the window.
- f. Tape is applied as indicated in diagram.

3. Method 3



For permanent use on stiff boards which can stand on their own.

- a. Cut strips of dense acid-free paper 1" wide by 5" long. (Size is determined by the object).
- b. Fold as diagrammed.
- c. Position the object in the mat. Mark position at corners in pencil.
- d. Apply a dot of Elvace to the back of the two flaps of the bottom photo corners and adhere to mat at marked positions.
- e. Position art. Slip unattached flaps under.

- E. **Sink Mat Or Tub:** A deep, walled, custom-fitted sink mat or "tub" with the option of supportive cushions may be constructed to accommodate thick or warped objects which do not permit hinging in a frame with brads or plates. Provides safe housing and unframing of works on thick, warped, or brittle boards; protects thick objects with soft, delaminating or brittle edges; allows construction of a deep space

between a sensitive surface and the frame glazing.

An outer laminated perimeter wall of acid-free corrugated cardboard (and/or ragboard) is built up on a base of one or two layers of acid-free cardboard, using carefully measured strips adhered together with Scotch Brand double-sided tape No. 415. Two side walls may be designed with long hinges to allow opening for easy positioning and removal of the work of art. If the object is warped, a bed of small cushions may be made by wadding rolls or balls of acid-free tissue, covered with the same tissue for a smooth surface. The balls - ranging in size as required - are placed in the necessary configuration to fill any gaps between the object and the base of the tub, without creating additional stresses or pressures. Scotch Brand Double-Sided Tape No. 415 is used to adhere the cushion covers to the cushions (at their bases to obviate proximity with the art) and to secure the cushions to the tub base.

The outer cardboard wall is built up to be level with the surface of the object. The inner side of the wall may be lined with Mylar or an appropriate paper when very friable edges are a concern. Strips of Mylar or heavy paper (the latter lined with burnished Japanese paper or glassine for friable media) measured to just overlap the edges of the art object are then attached to the top edges of the level walls to hold the object in place; Double-side Tape 415 is used as adhesive (see 40.5.3. Japanese Tissue Perimeter Mount). A window mat and glazing may then be placed over the tub. Thick spacers may be attached to the glazing for objects which require additional air space. The accompanying pressure created by the mat or spacers also aid in holding the work in place. If desired, tub edges and glazing spacers may be concealed by a wide frame rabbet. Revealed aspects of the construction are covered with ragboard. A sealed package with or without Mylar backing may then be made to create a single unit which is easily situated. (DT, FZ)

40.5.3. Framing Without A Mat

- A. A Spacer or fillet (a separating strip made of wood, plastic, or ragboard) is inserted around the inside perimeter of a frame. It is placed inside the rabbet of the molding and rests against the glazing to create space between the object and the glazing material. Commercially available "S" shaped spacers (Frame-Space) are available in clear plastic with attached pressure-sensitive tape. Some metal frames are currently available with a construction which includes a spacer.
1. **Strips of Plexiglas:** Square Plexiglas rods (1/4, 1/2, 5/8 or 1" widths) attach with difficulty to frames. Won't adhere to wood with tape, stick indifferently to metal. Best to attach to acrylic glazing with 3M double-sided tape. Forms a good bond and this is easier for later framing.
 2. **Wood Strips:** Problems of acidity and difficulty of sealing wood (must be coated with inert substance such as B-72) potential staining of object. Will glue to wood or metal, won't stick with double-sided acrylic tape. Not recommended.
 3. **Ragboard:** Cut on board shears and adhered with Elvace to desired thickness. Will stick to frame with double-sided acrylic tape or Elvace. Ragboard is preferred as a stable material.

- 4. Strips of Plexiglas Covered With Ragboard:** Spacers which will not be hidden by frame rabbet can be lined with ragboard strips adhered with 3M double-sided tape. (EKS)
- B. Tray Mat For Floated Objects:** Holds glass above the surface of the work without use of spacers.
1. Cut a sheet of 4-ply acid-free matboard 1/2" larger on both sides (e.g. 16 1/2"x 20 1/2").
 2. On the reverse of the matboard, mark 3/8" in from all edges.
 3. Cut halfway through thickness of the matboard along the marks. (Some mat-cutters have depth settings.) Avoid cutting too far.
 4. Turn matboard over (face up) and lightly score the reverse of the cuts with a bone folder.
 5. Still face up, mitre cut and remove corner blocks.
 6. Fold scored edges up to create vertical walls and secure at the corners.
 7. Cut two strips 1/2"x 20" and two strips 1/2"x 16" of 4-ply matboard (same color) and adhere the strips to the vertical walls using 1/4" double-sided tape.
 8. The glass is held on the top edge of the tray walls. Seal all edges with clear polyester film tape to create a package and prevent movement of the glass. It is very effective to float-hinge the work onto an acid-free panel slightly smaller than the dimensions of the work, then elevate it slightly above the tray. (HM, UH)

40.5.4 Problems encountered in travel

A. Spots on Plexiglas:

May be caused by reaction with solvents in printer's ink or may be a micro-breakdown of the Plexiglas surface due to vibration and abrasion, usually associated with trucking. (BF, MHE)

B. Taping glass for travel:

Glass is routinely taped to prepare framed objects for travel. Be sure not to tape any part of the frame as the tape adhesive can damage the molding finish. Never apply tape to Plexiglas. It is impossible to remove the adhesive. Taping doesn't get under edge of rabbet where the glass may still splinter and damage the object.

(DT,FZ) To prevent this, tape glass to the inner rabbet of the frame to act as a shock absorber and prevent shards from moving if it should break. (MB)

1. Use masking tape, drafting tape, or similar pressure sensitive tape, or clear contact paper sheets.
2. Apply the tape in strips that overlap slightly. (If not overlapped, they should be no more than 1/4" apart.)
3. Allow extra tape at the end of the strip. Double tape over to form a tab (with the adhesive on the inside) for later removal.

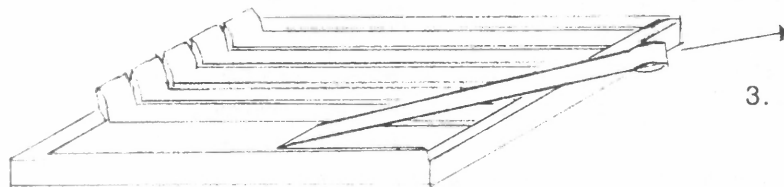

4. To remove: grasping the tab, pull back on the tape at an angle close to the surface of the glass. Do not pull tape at right angle to the glass as this introduces a strain on the glass and may break it.
 5. Use a single-edged razor to scrape away residual tape and adhesive. Alcohol may be used to remove tape-adhesive residues from Denglas. (MHE)
- C. Travel mat:** Floated objects hinged even at sides and bottom may tend to be pulled towards a Plexiglas glazing. Even under the best of conditions, a floated object may travel face down during part of its transit. Another option is a travel mat: a wraparound window which catches the edges of the work during transit, yet which may be flipped around to the back after arrival at the borrowing institution - revealing an exhibition float mat. This requires unframing and some additional handling, but in special circumstances may be a useful alternative. (DT,FZ)

40.5.5 Adapting Old Mats and Frames:

Often, old mats and frames may be altered for continued use. Frequent problems are objects framed directly against glass, poor quality materials used for old decorative mats, and subsequent attachment to poor quality backings. In these cases, more or less visually intrusive methods may be used to separate objects from glazing and poor quality materials with stable materials. Brittle or acidic backings and strong or crosslinked adhesives present potential for damage to the object. These and subsequent mounting materials that have altered (e.g. flattened) the appearance of the object and its presentation require removal. However, it is desirable to preserve historic formats of well-known collections, such as the elaborate mats prepared for old master drawings by Mariette, and to retain the presentations artists have devised for their own work. In some cases, objects such as Alfred Stieglitz's photos mounted on boards or John Marin's framed drawings and watercolors, may not be altered for purposes of conservation without interfering with the artist's intent.

A. To save an old but acidic mat - Method 1:

Line with a 2-ply ragboard and seal bevel with several coats of Hyplar acrylic medium.

B. To save an old but acidic mat - Method 2:

1. Adhere a sheet of 4-ply overall to the verso of the mat with Elvace. Weight and let dry overnight.
2. Recut the window setting the tip of your knife 1/16" behind the old mat bevel. (This is easy with a matcutter that works from the face of the mat. If yours works from the back, this operation will involve some tricky measuring.)
3. Cut 1/4" strips of dense acid-free paper - old handmade is best - and mitre on end. (Use tea-chest paper for a "gilded" bevel.)
4. Run a thin bead of Elvace along one side of the double-ply mat bevel.
5. Lay the mitred end of the paper strip into the corner of the mat window on the bevel. Run the strip of paper with your thumb along the bevel, lining up the strip edge with the top (front) edge of the bevel.
6. Cut the other end of the paper strip off on an angle to fit the window corner.
7. Burnish paper down against bevel with thumbnail.
8. Run a thin bead of Elvace along the edge of the paper strip projecting to the back. Wait a second, then fold the strip neatly to the back and burnish it down.

9. Repeat for the other three bevels. (MBC)

- C. **Adapting Old Frames:** Old glass may be saved for more aesthetically consistent use in old frames. Often, old framing methods may not have included adequate separation between the object and the glazing. In order to adapt old frames, a spacer may be required. In cases where a spacer may not be attached to

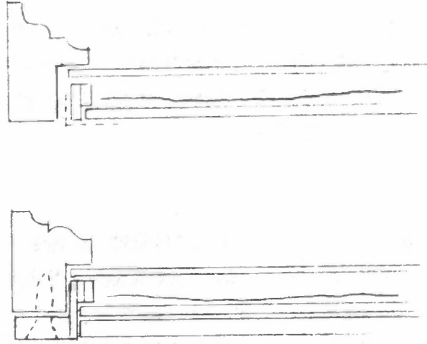

new glazing, other solutions may apply. 1.

New glazing: A spacer may be adhered to glass or acrylic when glazing is new.

2. Old Glass: A ragboard spacer may be built up to the width allowed by the frame rabbet. The spacer may be attached to the backboard using a linen tape hinge the length of the backboard. The spacer is a four-sided window.
3. Shallow Frame: When the frame is too shallow to allow addition of spacers, the back of the frame may be built up to increase depth. Wooden side may be screwed to the back of the frame to extend the back safely without harming the frame.
4. Turn buttons and screws may be used on fragile or antique frames.

40.5.6 Precautions for Uncontrolled Environments:

- A. **Sealed Packages:** Buffer the work from drastic fluctuations in temperature and humidity and from airborne pollutants and dust. The sealed package must be placed in a frame for exhibition purposes. To frame, place the sealed package into the frame and secure with brads or mending plates. A sealed package may be constructed using glazed material at the front, then the matted work, acid-free backing materials and polyester film at the reverse which is sealed around the edges with polyester film tape. Acid-free paper is placed around the edges before sealing with the tape so that the adhesive sticks only to the glazing material and the polyester film. Sealed packages can also be made with square Plexiglas spacers attached to the glazing materials in cases where additional separation of the work from the glazing material is required. (EKS)
- B. **Sealing frames:** This method is not recommended. Sealing the back and edges with a foil or heavy Mylar vapor barrier to protect against changes in temperature and relative humidity can backfire, trapping humidity inside or slowing the release of humidity outward, if moisture has entered from the front. A safer solution is the use of a sealed package which is inserted into the frame.
- C. **Use of Art Sorb and Silica Gel:**
1. Art Sorb can be placed into the sealed package between the acid-free backing and the Mylar layers. This system has been effective when used for traveling exhibitions that go to uncontrolled environments. (EKS)
 2. As a less expensive alternative, silica gel may be introduced into a sealed

package by "quilting" the loose pellets between the backing and a sheet of polyester web. Use double sided tape (and run a bead of Elvace along the top of the top for a more permanent bond) to hold the pellets in place. Cover with Mylar then add the acid-free corrugated backboard. Seal the edges of the whole package, from acrylic sheet to acid-free backboard with tape that will act as a moisture barrier, such as metal foil tape. Cut a window in the acid-free corrugated backboard so that the indicator can be read. (Instruct borrowers or owners on how to proceed if indicator reading changes.)

40.5.7 Precautions Against Mold:

Thymol-impregnated blotters have been recommended for enclosure in matting packages (against the backing) to prevent mold growth. In general, it is not recommended to seal or enclose any of the known fungicidal compounds in close contact with paper objects because all are known to discolor paper.

40.5.8 Decorative Mats

A. "French" Mats:

French mats may be made on ragboard or on color paper adhered to ragboard (by dry mounting, pasting, contact cements of the new non-staining varieties). Colored papers may be mounted before the mat is cut. If you mount it afterward, you will have to cut out the window and wrap an inner margin of paper around the back of the mat window, much like steps 13-15 in the silk-mat making instructions (See 40.5.9.B Fabric Covered Mats).

French mats may be drawn and painted in watercolor or ink. Each gives a slightly different effect, depending upon opacity, brilliance, etc. Usually, "less is more."

1. Lay out a sample french mat in pencil on scrap paper. The lines and the intervals between them may be any weight or distance apart desired. Remember, however, that intervals which are identical or even multiples of each other will tend visually to flatten the mat.
2. Draw a 45 degree angle line across the sample and measure the distances between line intersections. Extend these measurements from the window corners at a 45 degree angle and mark with a light pencil point or pin. Connect the marks with ruled pale pencil lines.
3. Apply watercolor wash to areas which should read as colored broad bands in the finished mat. Use a broad flat brush held at an angle and mix the color to a greater dilution than the desired final color. Starting with a diagonal cut-in at any corner, run the brush along the band, keeping within the pencil outlines, holding the mat at a slight angle and proceeding downhill. Go around the mat twice in this fashion, ending with a diagonal cut- out which exactly meets the beginning of your stroke. Pick up with a slightly moist brush any puddle at the end. Lay the mat aside, flat on the table, until dry.
4. Apply further washes one full turn around the mat at a time until the band is the desired shade. Each additional wash should be begun at a different corner. Narrow bands may be painted after the lines are painted.
5. After all washes are completely dry, colored lines may be drawn with a ruling pen. Begin with the innermost lines and proceed to the outermost, finishing

each set of our before beginning the next. Vary their hue and thickness for a variety of effects.

6. After the mat is painted, gold strips may be applied if desired. These may be carefully cut with a rule from gold tea chest paper or may be purchased in strips from some art supply houses. Real gold leaf may be purchased in strip form. Each kind of gold is applied in a different manner, and individual techniques must be perfected. The new non-staining contact adhesives are easiest for paper gold, but the lines look better if a water-based adhesive such as white glue is used. The handling difficulties are incredible, however. Gold leaf is a whole art in itself. After the gold strips are applied, an outline may be drawn along side to minimize any irregularities. (MBC)
Methyl cellulose can also be added to watercolor washes to increase surface tension and slow spreading/flow. (ML)

B. Fabric Covered Mats - Method 1:

This method is satisfactory for any fairly light-weight, closely woven fabric including silk, cotton, light-weight linen, even velvet or denim.

1. Tear fabric 2" larger than outer mat dimensions.
2. Lay fabric right side down on a clean, soft wood table or board.
3. Lay mat right side down on fabric with fabric margins approximately equal at all edges.
4. Put a push pin in at any corner of the mat window.
5. Pulling the fabric finger-taut and lining up fabric grain with window edge, put push pins in other three window corners in order around the window. Pull the fabric out diagonally to place last push pin. Be certain that the fabric grain is straight relative to window edge.
6. Put a push pin in any outer corner of fabric just beyond the mat's corner, pulling the fabric taut so that the margins of the fabric are equal to the margin perpendicular to the pins at the window corners when the fabric is pulled taut against the pins.
7. Put in the other three corner pins in order around the mat in a similar manner, lining up the grain of the fabric with the outer edges of the mats and keeping the fabric uniformly taut.
8. Cut off the fabric margins diagonally at the corners just beyond the pins.
9. Apply a thin film of white glue (polyvinyl acetate emulsion, e.g. Elvace) along an outer edge of the mat. It should extend about an Inch In from the edge. Fold over fabric and press firmly. Be careful to fold the fabric perpendicular to the mat edge and to keep the grain of the fabric even with the mat edge from pin to pin. When the edge is completely pasted (but not completely dry), pull the two corner pins and place them along the edge to hold the mat in position.
10. Do the opposite edge in a similar way but under tension, pulling against the edge already pasted so that the grain of the fabric is even with the mat edge from pin to pin.
11. Do the other two edges, at times pulling the fabric taut and keeping the grain straight. Fold over excess fabric at the corners with a small drop of paste. All

outer edges of the fabric should now be pasted and the mat held in place on the table on two opposite sides. One can just the success of the work so far by the flatness of the turned-over margins.

12. Pull the four pins in the window corners and set them at two unpinned outer edges of the mat.
13. Slit the fabric within the window area with a very sharp blade from corner to corner diagonally across the middle. If the window is large, the center may be cut out whole, to be used for a small mat, but at least 1" of fabric must remain within the mat window's edges. Cut this inner margin diagonally exactly to the window's corners.
14. Apply a film of white glue along one edge of the window, being careful to place it exactly to the corners without allowing it to run over to the bevel edge. Pull the inner fabric margin at this edge taut and fold it perpendicularly back. Press it into the adhesive, being careful to hold the very corners down until they hold firm. Be very careful to maintain even tension and the straight grain of the fabric against the window ledge.
15. Do the opposite window edge and then the other two in the same way.
16. Corrections: The mat is now finished, and one may pull the pins and take a look. If the window corners are not square and firmly down, slit the fabric further with a very sharp blade and insert a little bit of adhesive on a toothpick, pressing into place delicately with a clean fingertip or tool. If there are puckers at the window corners or elsewhere, detach the outer edge fabric margin at the point where the grain continues around the edge from the pucker, apply more adhesive, pull taut and reglue.
17. Using the mat immediately: Lay strips of acid-free paper around the inner edge to prevent the white glue which may have seeped through the fabric from coming in contact with the work of art. An inner liner of ragboard may also be used, and the cream-colored bevel, if allowed to show is often an effective contrast to the fabric. If the mat can be set aside for several days to dry in the air, a liner is less necessary. (MBC)

C. Fabric Covered Mats - Method 2:

The mat is cut to the proper size, then coated one or two times with a 50/50 mixture of Rhoplex AC33 and N580. The bevel should also be coated and about 1" in from the window on back. When dry, the fabric is laid on top and aligned so that the grain is straight. It is then ironed with the iron set at about 225-250 degrees. It should not be pulled too hard. When the surface is ironed flat, one may iron the bevel with a tacking iron or regular iron. If not exactly right (if the iron was not hot enough) adjustments can be made by pulling over the fabric and realigning. Here the iron should be hot. Pull fabric and iron in place. Line window mat with 2-ply or Mylar. (ML)

D. Paper Covered Mats

1. Method 1:

- a. Choose either a board where the facing paper is also available as separate

sheets (Canson, Crescent) or an appropriate paper to be mounted to the board.

- b. Mount the paper over the entire face of the mat with S & W Special Mounting Paste.
 - c. Cut the window.
 - d. Face the bevel with paper as described in 40.4.5.
 - e. Line the window mat with 2-ply ragboard if it is to be an overmat (if mat will be in contact with the object.)
- 2. Paper wrapped window - Method 2 (one piece)**
- a. Cut a window and save the cut out.
 - b. Using mounting paste, cover one side of the covering paper to be used.
 - c. Apply the paper to the face of the window and allow it to dry.
 - d. Placing the window cut out and press it down onto the damp paper over the opening.
 - e. Take the window and paper on a waterproof working surface such as Mylar or polyethylene, wet the portion over the opening.
 - f. When the paper pressed by the cut out onto the bevel has dried, cut the paper in the window out in an X shape, with cuts starting at the corners and proceeding toward the center.
 - g. Wrap the flaps of paper around to the back of the window and adhere.
 - h. Line with 2-ply ragboard if it is an overmat.
- 3. Paper wrapped window - Method 3 (two piece)**
- a. Cut a bevelled window mat and a straight cut 2-ply mat to fit the top of the bevelled opening on the face of the window.
 - b. Cut paper strips to cover the bevel as described in 40.4.5.
 - c. Apply paper to the face of the 2-ply window with mounting paste, cut out the paper covering the opening and wrap the flaps around to the back.
 - d. Adhere the 2-ply window to the face of the window with the paper covered bevel and line the back with 2-ply ragboard if it is an overmat.

E. Gilded Bevels:

1. **Method 1:** to make one's own gold leaf paper, use a smooth thin Japanese tissue and apply one or two thin coats of Rhoplex AC33 (add some Rhoplex N580 if better adhesion is needed). When dry, one needs only to lay the leaf on top and burnish to make it adhere. A layer of silicone release paper should be between the burnisher and leaf. Then strips of this leafed paper may be cut to proper width. (ML).
2. **Method 2:** See instructions for paper-covered bevel under **40.5.5.B To Save An Old But Acidic Mat**. Gild paper first, then cut into strips and apply as described above. (MBC)
3. **Method 3:** The easiest thing to use is homemade gum arabic solution, applied to bevel and allowed to dry. Remoisten each 2" section with breath prior to applying the leaf. (MBC)
4. **Method 4:** If you can allow bevel to dry thoroughly and it will not be in contact with the object, use oil gold size. (Windsor and Newton have stopped marketing their watersoluble gold size.) (MBC)

40. Matting and Framing

May 1988

Compilers: Sarah Bertalan, Hugh Phibbs

Liaison: Sarah Bertalan

Contributors: Margaret Brown, Karl Buchberg, Marjorie B. Cohn, Antoinette Dwan, Margaret Holben Ellis, Reba Fishman, Betty Fiske, Ursula Hobson, Antoinette King, Leslie Kruth, Murray Lebwohl, Holly Maxson, Sarah Melching, Meredith Mickelson, Kitty Nicholson, Debbie Hess Norris, Antoinette Owen, Franklin Shores, Elizabeth Kaiser Schulte, Denise Thomas, John Thompson, Dianne van der Reyden, Paula Volent, Faith Zieske.